



Se é Skymesen, pode confiar.
 In Skymesen you can trust.
 Si es Skymesen, puedes confiar.



CONFORMS TO UL STD 763, NSF STD 8
 CERTIFIED TO CSA C22.2 STD No. 195



CATALOG

CATÁLOGO





Our history - *Nuestra historia*

- 1963** • **Founded in Brazil as a manufacturer of water pumps and bench drills.**
Fundada en Brasil como fabricante de bombas de agua y taladros de banco.
- 1968** • **Enters the food processing equipment market.**
Ingresa en el mercado de equipos para el procesamiento de alimentos.
- 1970** • **Becomes the leading company in the segment within the Brazilian market.**
Alcanza el puesto de empresa líder del sector en el mercado brasileño.
- 1987** • **Starts exporting its products to all continents.**
Pasa a ser propietaria de una parte preservada de la Mata Atlántica en Brasil.
- 1997** • **Becomes the owner of a preserved area of the Atlantic Forest in Brazil.**
Pasa a ser propietaria de una parte preservada de la Mata Atlántica en Brasil.
- 2000** • **Researches and develops innovative products.**
Investiga y desarrolla productos innovadores.
- 2008** • **Establishes a strong export partnership in North America.**
Implementa una sólida alianza de exportación en América del Norte.
- 2020** • **Implements Industry 4.0 in its production process and establishes a strong distribution partnership in Europe**
Implementa la Industria 4.0 en su proceso productivo e inicia una fuerte alianza para la distribución de sus productos en Europa.
- 2023** • **Celebrates 60 years as a benchmark in the Brazilian business landscape, anticipating trends and pioneering in various markets.**
Celebra sus 60 años como referencia en el panorama empresarial brasileño, anticipando tendencias y siendo pionera en diferentes mercados.

Skymssen brand evolution *Evolución de la marca Skymssen*



A story of overcoming and innovation *Una historia de superación e innovación*

Since 1963, Skymssen has been growing alongside its customers, offering innovative solutions for the foodservice sector and making people's lives easier. Through the combination of design and advanced technology, Skymssen products have become a benchmark in quality, safety, and efficiency in the global market, serving a wide range of segments in the food industry.

Desde 1963, Skymssen ha ido creciendo junto a sus clientes, ofreciendo soluciones innovadoras para el sector de foodservice y facilitando la vida de las personas. A través de la unión entre diseño y alta tecnología, los productos Skymssen se han convertido en un referente de calidad, seguridad y eficiencia en el mercado mundial, atendiendo a los más diversos segmentos del sector alimentario.

BUTCHERY

VERTICAL SAUSAGE STUFFER	05
MEAT TENDERIZERS	07
MEAT SLICERS	11
MEAT MIXERS	12
MEAT GRINDERS	13
MEAT GRINDERS WITH STAINLESS STEEL MOUTH	16
HOMOGENIZERS	18
TABLE BAND SAWS	19
BAND SAWS	20

SLICER

AUTOMATIC SLICER	27
------------------	----

BAR AND RESTAURANT

CUTTERS	29
PEELERS	31
CITRUS JUICERS	35
FRUIT PULPER MACHINES	39
ELECTRIC FRYERS OIL	41
COLD ZONE FRYERS	42
ELECTRIC FRYER SPLIT COLD ZONE	43
ELECTRIC FRYERS WATER AND OIL	44
COLD ZONE GAS FRYERS	45
HIGH SPEED BLENDERS	47
COMMERCIAL BLENDERS	53
COMMERCIAL TILTING BLENDERS	55
HAND MIXER	57
FOOD PROCESSOR	58
GRATERS	62
DOUGH OPENERS	64
STONE DECK OVENS	66
COMMERCIAL MICROWAVE OVENS	67

ICE CREAM PARLOR

MILKSHAKE MIXERS	69
------------------	----

BAKERY

PLANETARY MIXERS	71
DOUGH ROLLERS	72
BREAD CRUMB MILLS	73
DOUGH DIVIDERS	74
CONVECTION TURBO OVENS	75

LAVADORA

DISHWASHER	77
------------	----

CARNICERÍA

EMBUTIDORA DE CHORIZO VERTICAL	05
ABLANDADORES DE CARNES	07
CORTADORAS DE CARNES	11
MEZCLADORAS DE CARNE	12
MOLINOS DE CARNES	13
MOLINOS DE CARNES CON BOCA INOXIDABLE	16
HOMOGENEIZADORES	18
SIERRAS DE BANCADA PARA HUESOS	19
SIERRAS PARA HUESOS	20

CORTADORA DE FIAMBRES

CORTADORAS DE FIAMBRES AUTOMÁTICAS	27
------------------------------------	----

BAR Y RESTAURANTE

PROCESADORA CUTTER	29
PELADORAS	31
EXPRIMIDORES DE CÍTRICOS	35
DESPULPADORAS DE FRUTAS	39
FREIDORAS ELÉCTRICAS ACEITE	41
FREIDORAS ELÉCTRICAS ZONA FRÍA	42
FREIDORA ELÉCTRICA CUBA DIVIDIDA ZONA FRÍA	43
FREIDORAS ELÉCTRICAS AGUA Y ACEITE	44
FREIDORAS A GAS DE ZONA FRÍA	45
LICUADORA DE ALTA VELOCIDAD	47
LICUADORAS COMERCIALES	53
LICUADORAS COMERCIALES BASCULANTE	55
MIXER DE MANO	57
PROCESADORAS DE ALIMENTOS	58
RALLADORES	62
ABRIDORAS DE MASAS	64
HORNOS DE PIEDRA REFRACTARIA	66
HORNOS MICROONDAS COMERCIALES	67

HELADERÍA

BATIDORAS DE MILKSHAKE	69
------------------------	----

PANADERIA

BATIDORAS PLANETARIAS	71
CILINDROS DE MASAS	72
MOLINOS DE PANES	73
DIVISORA DE MASAS	74
HORNOS TURBO ELÉCTRICO	75

LAVADORA

LAVAVAJILLA	77
-------------	----



BUTCHERY - CARNICERÍA

The Butcher line features robust and efficient equipment that offers greater durability, versatility, and maximum safety for the operator. La línea Carnicería presenta equipos robustos y eficientes que ofrecen mayor durabilidad, versatilidad y máxima seguridad para el operador.

The line offers solutions for all butcher shop needs, such as meat tenderizers and slicers, meat mixers and homogenizing grinders, choppers, band saws, and sausage stuffers. La línea ofrece soluciones para todas las necesidades de una carnicería, como ablandadores y cortadoras de carne, mezcladoras y molidoras homogeneizadoras, picadoras, sierras de cinta y embutidoras.



VERTICAL SAUSAGE STUFFER EMBUTIDORA DE CHORIZO VERTICAL

SAUSAGE STUFFER, ESSENTIAL IN THE PRODUCTION OF ARTISANAL SAUSAGES.
EMBUTIDORA, ESENCIAL EN LA FABRICACIÓN DE EMBUTIDOS ARTESANALES.



BUTCHERY
CARNICERÍA

EL3 / EL5 / EL7

VERTICAL SAUSAGE STUFFER, STAINLESS STEEL, 10 LITERS / 15 LITERS
EMBUTIDORA DE CHORIZO VERTICAL INOXIDABLE, 10 LITROS / 15 LITROS



- ✓ Total stainless steel construction
Construcción totalmente en acero inoxidable

- ✓ Relief valve
Válvula de alivio

- ✓ Steel gears
Engranajes en acero

- ✓ Two speeds
Dos velocidades

- ✓ Removable cylinder
Cilindro removible



Includes 4 stainless steel funnels
Incluye 4 embudos de acero inoxidable



MODEL / MODELO	EL3	EL5	EL7
Dimensions (H x W x L) Dimensiones (Al x An x L)	190 x 185 x 605 mm	190 x 185 x 705 mm	190 x 185 x 845 mm
Package size (H x W x L) Dimensiones del embalaje (Al x An x L)	370 x 365 x 565 mm	370 x 365 x 680 mm	370 x 365 x 835 mm
Cylinder volume Volumen del cilindro	3 L	5 L	7 L
Capacity Capacidad	2,5 kg	4 kg	5,5 kg
Cylinder dimensions (ØxP) Dimensiones del cilindro (ØxP)	Ø 139 x 200 mm	Ø 139 x 315 mm	Ø 139 x 450 mm
Net / gross weight Peso neto / bruto	8,00 kg / 9,20 kg	9,80 kg / 11,20 kg	12,40 kg / 14,30 kg
HS code Partida arancelaria	84385000	84385000	84385000

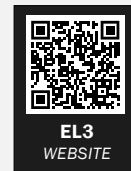

EL3
WEBSITE

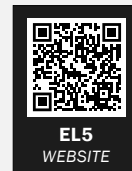

EL5
WEBSITE

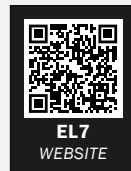

EL7
WEBSITE

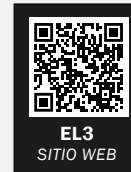

EL3
SITIO WEB

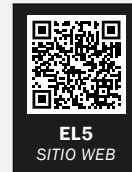

EL5
SITIO WEB

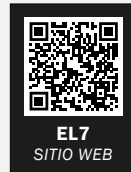

EL7
SITIO WEB

ILLUSTRATIVE PHOTO. ACTUAL PRODUCTS AND ACCESSORIES MAY CHANGE.
FOTO ILUSTRATIVA. PRODUCTOS REALES Y LOS ACCESORIOS PUEDEN CAMBIAR.



In Skymesen you can trust.
Si es Skymesen, puedes confiar.

5

www.skymesen.com



BRAZILIAN INDUSTRY
INDUSTRIA BRASILEÑA



VERTICAL SAUSAGE STUFFER EMBUTIDORA DE CHORIZO VERTICAL

SAUSAGE STUFFER, ESSENTIAL IN THE PRODUCTION OF ARTISANAL SAUSAGES.
EMBUTIDORA, ESENCIAL EN LA FABRICACIÓN DE EMBUTIDOS ARTESANALES.



BUTCHERY
CARNICERÍA

EL10V / EL15V

VERTICAL SAUSAGE STUFFER, STAINLESS STEEL, 10 LITERS / 15 LITERS
EMBUTIDORA DE CHORIZO VERTICAL INOXIDABLE, 10 LITROS / 15 LITROS



- ✓ Total stainless steel construction
Construcción totalmente en acero inoxidable
- ✓ Relief valve
Válvula de alivio
- ✓ Steel gears
Engranajes en acero
- ✓ Two speeds
Dos velocidades
- ✓ Removable cylinder
Cilindro removible



Allows assembly for right-handed or left-handed individuals

Permite el montaje para personas diestras o zurdas.



Includes 4 stainless steel funnels

Incluye 4 embudos de acero inoxidable

MODEL / MODELO	EL10V	EL15V
Dimensions (H x W x L) <i>Dimensiones (Al x An x L)</i>	640 x 415 x 510 mm	775 x 420 x 510 mm
Package size (H x W x L) <i>Dimensiones del embalaje (Al x An x L)</i>	475 x 380 x 700 mm	475 x 385 x 835 mm
Cylinder volume <i>Volumen del cilindro</i>	10 L	15 L
Capacity <i>Capacidad</i>	8 kg	12 kg
Cylinder dimensions (ØxP) <i>Dimensiones del cilindro (ØxP)</i>	Ø 216 x 270 mm	Ø 216 x 405 mm
Net / gross weight <i>Peso neto / bruto</i>	14,4 kg / 16,7 kg	18 kg / 20,90 kg
HS code <i>Partida arancelaria</i>	84385000	84385000



EL10V
WEBSITE

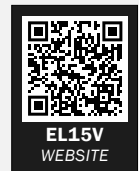

EL15V
WEBSITE

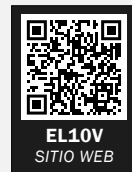

EL10V
SITIO WEB



EL15V
SITIO WEB



In Skymssen you can trust.
Si es Skymssen, puedes confiar.

6

www.skymssen.com



ILLUSTRATIVE PHOTO. ACTUAL PRODUCTS AND ACCESSORIES MAY CHANGE.
FOTO ILUSTRATIVA. PRODUCTOS REALES Y LOS ACCESORIOS PUEDEN CAMBIAR.



MEAT TENDERIZERS ABLANDADORES DE CARNES

TENDERIZES BEEFS BY BREAKING MEAT'S FIBERS, MAKING IT SOFTER.
ABLANDAR CARNES DE MANERA RÁPIDA Y EFICIENTE, AUMENTANDO LA PRODUCTIVIDAD Y GANANCIAS DE TU NEGOCIO.



BUTCHERY
CARNICERÍA

ABS

MEAT TENDERIZER, STAINLESS STEEL, WITH SAFETY SYSTEM
ABLANDADOR DE CARNES, INOXIDABLE, CON SISTEMA DE SEGURIDAD



- ✓ Lid with safety switch
Tapa con sensor de seguridad
- ✓ Beef capacity of up to 1,3 cm thick, 15 cm long
Capacidad para carne de res de hasta 1,3 cm de espesor y 15 cm de ancho
- ✓ Steel gears
Engranajes en acero
- ✓ Easily removable roller system
Fácil retirada del conjunto de rollos
- ✓ Optional accessory enables you to slice meat into strips
Kit opcional para corte en fajitas



MEAT STRIP CUTTER KIT: KIT PARA CORTAR FAJITAS:

KES-AB/ABS 10 - 10 mm
ACCESSORY SOLD SEPARATELY
ACCESORIO VENDIDO POR SEPARADO



MODEL / MODELO	ABS
Voltage / frequency / phases <i>Tensión eléctrica / frecuencia / fases</i>	110 V / 60 Hz / 1 220 V / 50 Hz / 1 220 V / 60 Hz / 1
Power rating <i>Potencia</i>	0,5 HP
Dimensions (H x W x L) <i>Dimensiones (Al x An x L)</i>	470 x 260 x 500 mm
Package size (H x W x L) <i>Dimensiones del embalaje (Al x An x L)</i>	500 x 320 x 530 mm
Net / gross weight <i>Peso neto / bruto</i>	24,30 kg / 26,30 kg
Approximate output <i>Producción aproximada</i>	400 kg/h
Max. beef thickness <i>Espesor máximo de la carne</i>	13 mm
Max.beef Width <i>Ancho máximo de la carne</i>	150 mm
HS code <i>Partida arancelaria</i>	84385000



ABS
WEBSITE



ABS
SITIO WEB

ILLUSTRATIVE PHOTO. ACTUAL PRODUCTS AND ACCESSORIES MAY CHANGE.
FOTO ILUSTRATIVA. PRODUCTOS REALES Y LOS ACCESORIOS PUEDEN CAMBIAR.



In Skymssen you can trust.
Si es Skymssen, puedes confiar.



www.skymssen.com



BRAZILIAN INDUSTRY
INDUSTRIA BRASILEÑA



MEAT TENDERIZERS ABLANDADORES DE CARNES

CUT BEEFS INTO STRIPS FOR MULTIPLE CULINARY USES
CORTE FAJITAS UNIFORMES Y DE MANERA RÁPIDA



BUTCHERY
CARNICERÍA

ABSC

MEAT STRIP CUTTER, STAINLESS STEEL, WITH SAFETY SYSTEM
CORTADORA DE CARNE EN FAJITA, INOXIDABLE, CON SISTEMA DE SEGURIDAD

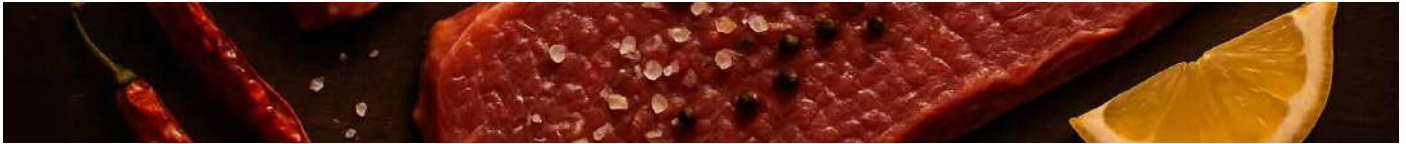

- Cut meat into strips
Ideal para corte de fajitas
- Lid with safety switch
Tapa con sensor de seguridad
- Beef capacity of up to 1,3 cm thick, 15 cm long
Capacidad para carne de res de hasta 1,3 cm de espesor y 15 cm de ancho
- Steel gears
Engranajes en acero
- Easily removable roller system
Fácil retirada del conjunto de rollos



MODEL / MODELO	ABSC
Voltage / frequency / phases <i>Tensión eléctrica / frecuencia / fases</i>	110 V / 60 Hz / 1 220 V / 50 Hz / 1 220 V / 60 Hz / 1
Power rating <i>Potencia</i>	0,5 HP
Dimensions (H x W x L) <i>Dimensiones (Al x An x L)</i>	435 x 225 x 510 mm
Package size (H x W x L) <i>Dimensiones del embalaje (Al x An x L)</i>	480 x 280 x 530 mm
Net / gross weight <i>Peso neto / bruto</i>	23,10 kg / 25,00 kg
Approximate output <i>Producción aproximada</i>	400 kg/h
Max. beef thickness <i>Espesor máximo de la carne</i>	13 mm
Max. beef Width <i>Ancho máximo de la carne</i>	150 mm
HS code <i>Partida arancelaria</i>	84385000



ABSC
WEBSITE



ABSC
SITIO WEB

ILLUSTRATIVE PHOTO. ACTUAL PRODUCTS AND ACCESSORIES MAY CHANGE.
FOTO ILUSTRATIVA. PRODUCTOS REALES Y LOS ACCESORIOS PUEDEN CAMBIAR.



In Skymssen you can trust.
Si es Skymssen, puedes confiar.

8

www.skymssen.com



BRAZILIAN INDUSTRY
INDUSTRIA BRASILEÑA



MEAT TENDERIZERS ABLANDADORES DE CARNES

CUT BEEFS INTO STRIPS FOR MULTIPLE CULINARY USES
CORTE FAJITAS UNIFORMES Y DE MANERA RÁPIDA



BUTCHERY
CARNICERÍA

ABS-HD

MEAT STRIP CUTTER, STAINLESS STEEL, WITH SAFETY SYSTEM
CORTADORA DE CARNE EN FAJITA, INOXIDABLE, CON SISTEMA DE SEGURIDAD



- Cut meat into strips
Ideal para corte de fajitas
- Lid with safety switch
Tapa con sensor de seguridad
- Beef capacity of up to 1,3 cm thick, 15 cm long
Capacidad para carne de res de hasta 1,3 cm de espesor y 15 cm de ancho
- Steel gears
Engranajes en acero
- Easily removable roller system
Fácil retirada del conjunto de rollos

MEAT STRIP CUTTER KIT: KIT PARA CORTAR FAJITAS:

KES-ABSHD10
MEAT STRIP CUTTER KIT - ABS-HD 10 mm
KIT PARA CORTAR FAJITAS - ABS-HD 10 MM

KES-ABSHD12
MEAT STRIP CUTTER KIT - ABS-HD 12 mm
KIT PARA CORTAR FAJITAS - ABS-HD 12 MM

ACCESSORY SOLD SEPARATELY
ACCESORIO VENDIDO POR SEPARADO

MODEL / MODELO	ABS-HD
Voltage / frequency / phases <i>Tensión eléctrica / frecuencia / fases</i>	110 V / 60 Hz / 1 220 V / 50 Hz / 1 220 V / 60 Hz / 1
Power rating <i>Potencia</i>	0,5 HP
Dimensions (H x W x L) <i>Dimensiones (Al x An x L)</i>	465 x 245 x 530 mm
Package size (H x W x L) <i>Dimensiones del embalaje (Al x An x L)</i>	510 x 340 x 560 mm
Net / gross weight <i>Peso neto / bruto</i>	27,10 kg / 29,00 kg
Approximate output <i>Producción aproximada</i>	500 kg/h
Max. beef thickness <i>Espesor máximo de la carne</i>	20 mm
Max. beef Width <i>Ancho máximo de la carne</i>	170 mm
HS code <i>Partida arancelaria</i>	84385000



ABS-HD
WEBSITE



ABS-HD
SITIO WEB

ILLUSTRATIVE PHOTO. ACTUAL PRODUCTS AND ACCESSORIES MAY CHANGE.
FOTO ILUSTRATIVA. PRODUCTOS REALES Y LOS ACCESORIOS PUEDEN CAMBIAR.



In Skymesen you can trust.
Si es Skymesen, puedes confiar.

9

www.skymesen.com



BRAZILIAN INDUSTRY
INDUSTRIA BRASILEÑA



MEAT TENDERIZERS ABLANDADORES DE CARNES

TENDERIZES BEEFS BY BREAKING MEAT'S FIBERS, MAKING IT SOFTER.
ABLANDAR CARNES DE MANERA RÁPIDA Y EFICIENTE, AUMENTANDO LA PRODUCTIVIDAD Y GANANCIAS DE TU NEGOCIO



BUTCHERY
CARNICERÍA

ABN-HD

MEAT TENDERIZER, STAINLESS STEEL, WITH SAFETY SYSTEM, HEAVY DUTY
ABLANDADOR DE CARNES, INOXIDABLE, CON SISTEMA DE SEGURIDAD, HEAVY DUTY



- Lid with safety switch
Tapa con sensor de seguridad
- Gearbox made of steel
Caja de cambios de acero
- Beef capacity of up to 2 cm thick, 20 cm long
Capacidad para carne de res de hasta 2 cm de espesor y 20 cm de ancho
- Steel gears
Engranajes en acero
- Easily removable roller system
Fácil retirada del conjunto de rollos

MEAT STRIP CUTTER KIT: KIT PARA CORTAR FAJITAS:

KES-ABSHD10
MEAT STRIP CUTTER KIT - ABS-HD 10 mm
KIT PARA CORTAR FAJITAS - ABS-HD 10 MM

KES-ABSHD12
MEAT STRIP CUTTER KIT - ABS-HD 12 mm
KIT PARA CORTAR FAJITAS - ABS-HD 12 MM

ACCESSORY SOLD SEPARATELY
ACCESORIO VENDIDO POR SEPARADO

MODEL / MODELO	ABN-HD
Voltage / frequency / phases <i>Tensión eléctrica / frecuencia / fases</i>	110 V / 60 Hz / 1 220 V / 50 Hz / 1 220 V / 60 Hz / 1
Power rating <i>Potencia</i>	0,5 HP
Dimensions (H x W x L) <i>Dimensiones (Al x An x L)</i>	540 x 475 x 240 mm
Package size (H x W x L) <i>Dimensiones del embalaje (Al x An x L)</i>	590 x 510 x 310 mm
Net / gross weight <i>Peso neto / bruto</i>	24,20 kg / 27,100 kg
Approximate output <i>Producción aproximada</i>	500 kg/h
Max. beef thickness <i>Espesor máximo de la carne</i>	20 mm
Max. beef Width <i>Ancho máximo de la carne</i>	200 mm
HS code <i>Partida arancelaria</i>	84385000



In Skymesen you can trust.
Si es Skymesen, puedes confiar.

10

www.skymesen.com



ILLUSTRATIVE PHOTO. ACTUAL PRODUCTS AND ACCESSORIES MAY CHANGE.
FOTO ILUSTRATIVA. PRODUCTOS REALES Y LOS ACCESORIOS PUEDEN CAMBIAR.



MEAT SLICERS CORTADORAS DE CARNES

SLICE DIFFERENT KINDS OF BONELESS MEATS, AS WELL AS BACON AND SAUSAGES
REBANAR DIFERENTES TIPOS DE CARNES SIN HUESO, ASÍ COMO TOCINO Y SALCHICHAS



BUTCHERY
CARNICERÍA

FC-350

MEAT SLICER, STAINLESS STEEL, BLADE 350 MM
CORTADORA DE CARNE, INOXIDABLE, CUCHILLA 350 MM



PRECISE CUTS CORTES PRECISOS

The equipment allows a standardization of meat cutting in different thickness, including thin slices.

El equipo permite una estandarización del corte de la carne y lonchas extremadamente finas.

- Thickness regulator
Regulador de espesor
- Slices of up to 40mm
Rebanadas de hasta 40mm
- Ideal for steaks, bacon and carpaccio
Ideal para filetes, tocino, carpaccio y salchichas.
- Perfect for meat skewers and kebabs
Perfecto para pinchos y brochetas de carne.



DISC WITH GERMAN TECHNOLOGY

DISCO CON TECNOLOGÍA ALEMANA

Manufactured in Europe, with high quality materials, it provides greater cut precision, keeping the knife sharp for longer.

Fabricado en Europa, con materiales de alta calidad, proporciona una mayor precisión de corte, manteniendo el filo durante más tiempo.

MODEL / MODELO	FC-350
Voltage / frequency / phases Tensión eléctrica / frecuencia / fases	110 V / 60 Hz / 1 220 V / 50 Hz / 1 220 V / 60 Hz / 1
Power rating Potencia	0,5 HP
Consumption Consumo	0,37 kW-h
Dimensions (H x W x L) Dimensiones (Al x An x L)	525 x 750 x 720 mm 525 x 750 x 720 mm 525 x 750 x 760 mm
Package size (H x W x L) Dimensiones del embalaje (Al x An x L)	750 x 865 x 665 mm
Net / gross weight Peso neto / bruto	49,7 kg / 65,00 kg
Disc diameter Diámetro del disco	350 mm
Cutting thickness Espesor de corte	0-40 mm
HS code Partida arancelaria	84385000



FC-350
WEBSITE



FC-350
SITIO WEB

ILLUSTRATIVE PHOTO. ACTUAL PRODUCTS AND ACCESSORIES MAY CHANGE.
FOTO ILUSTRATIVA. PRODUCTOS REALES Y ACCESORIOS PUEDEN CAMBIAR.



In Skymesen you can trust.
Si es Skymesen, puedes confiar.

11

www.skymesen.com





MEAT MIXERS MEZCLADORAS DE CARNE

MIXES MINCED MEAT AND SEASONINGS
MEZCLAR CARNES Y CONDIMENTOS PARA LLEGAR A LA RECETA IDEAL.



BUTCHERY
CARNICERÍA

MMS-501

MEAT MIXER WITH COVER, 50 KG
MEZCLADORA DE CARNES, CON TAPA, 50 KG



BOOST YOUR BUSINESS PRODUCTIVITY

AUMENTE LA PRODUCTIVIDAD DE TU NEGOCIO

Ideal for the preparation of mixed meat for sausages and hamburguers.

Ideal para preparar mezclas para chorizo, hamburguesas y carne de ave condimentada.

- ✓ **Stainless steel tilting tank**
Tanque basculante inoxidable
- ✓ **Easy discharge of processed food**
Fácil remoción del alimento
- ✓ **Internal construction in stainless steel AISI 304**
Construcción interna 100% en acero inoxidable AISI 304
- ✓ **Perfect for meat skewers and kebabs**
Perfecto para pinchos y brochetas de carne.
- ✓ **Lid with safety sensor**
Sensor de seguridad en la tapa
- ✓ **Handle to move the unit**
Manija para facilitar el transporte
- ✓ **Pulse function**
Función pulsar



MODEL / MODELO	MMS-501
Voltage / frequency / phases Tensión eléctrica / frecuencia / fases	110/220 V / 60 Hz / 1 220 V / 50 Hz / 1
Power rating Potencia	0,5 HP
Consumption Consumo	0,37 kW-h
Dimensions (H x W x L) Dimensiones (Al x An x L)	1.000 x 390 x 940 mm
Package size (H x W x L) Dimensiones del embalaje (Al x An x L)	1.175 x 530 x 1.060 mm
Net / gross weight Peso neto / bruto	80,00 kg / 105,00 kg
Approximate output Producción aproximada	600 kg/h
Rotation Rotación	50 rpm
Tank capacity Capacidad del tanque	70 L / 50 kg
HS code Partida arancelaria	84385000



MMS-501
WEBSITE



MMS-501
SITIO WEB

ILLUSTRATIVE PHOTO. ACTUAL PRODUCTS AND ACCESSORIES MAY CHANGE.
FOTO ILUSTRATIVA. PRODUCTOS REALES Y LOS ACCESORIOS PUEDEN CAMBIAR.



In Skymssen you can trust.
Si es Skymssen, puedes confiar.

12

www.skymssen.com



BRAZILIAN INDUSTRY
INDUSTRIA BRASILEÑA



MEAT GRINDERS MOLINOS DE CARNES

DESIGNED TO GRIND CHILLED BONELESS MEAT.
DISEÑADOS PARA MOLER CARNE REFRIGERADA SIN HUESOS.



BUTCHERY
CARNICERÍA

PS10

MEAT GRINDER SIZE 10
MOLINO DE CARNE BOCA 10



POWER. PRECISION. PERFORMANCE.

POTENCIA, PRECISIÓN Y RENDIMIENTO

The PS10 Meat Grinder by Skymesen is ideal for everything from small home production to commercial demands in restaurants, farms, and small butcher shops. Designed to grind various types of meat such as beef, pork, chicken, and fish.

El molino de carne PS10 de Skymesen es ideal para atender desde pequeñas producciones domésticas hasta demandas comerciales en restaurantes, fincas y pequeñas carnicerías. Diseñado para moler diversos tipos de carne como res, cerdo, pollo y pescado.



DISCO 3 mm
DISCO 8 mm

ACCESSORY SOLD SEPARATELY
ACCESORIO VENDIDO POR SEPARADO

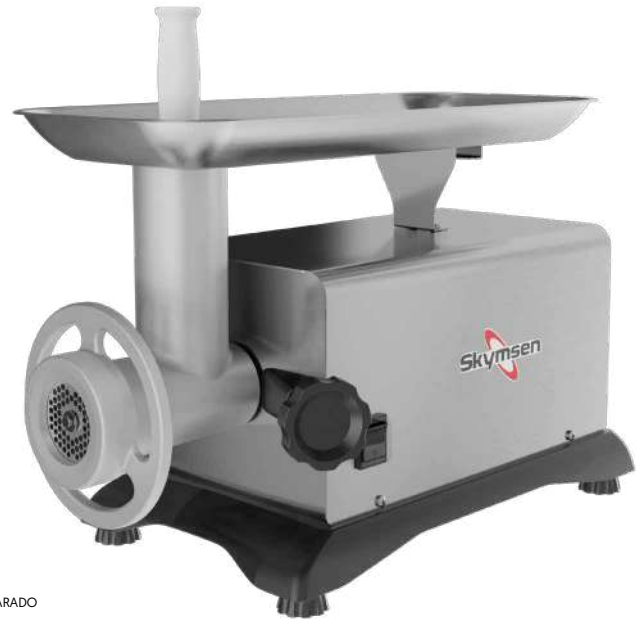

✓ 0.5 HP dual-voltage motor
Motor de 0,5 HP bivoltaje

✓ Stainless steel construction
Construido en acero inoxidable

✓ Easy to clean
Fácil limpieza

✓ Compact and ergonomic design
Diseño compacto y ergonómico

✓ Tinned cast iron head
Boca en hierro fundido estañado

✓ Includes 5 mm plate
Incluye disco de 5 mm

✓ Stainless steel housing and trays
Gabinete y bandejas en acero inoxidable

✓ Precision cutting system
Sistema de corte preciso

MODEL / MODELO	PS10
Voltage / frequency / phases Tensión eléctrica / frecuencia / fases	110 V / 60 Hz / 1 220 V / 50 Hz / 1 220 V / 60 Hz / 1
Power rating Potencia	500 W
Motor power Potencia del motor	0,5 HP-CV
Consumption Consumo	0,37 kW/h
Dimensions (H x W x L) Dimensiones (Al x An x L)	460 x 310 x 580 mm
Package size (H x W x L) Dimensiones del embalaje (Al x An x L)	445 x 370 x 620 mm
Net / gross weight Peso neto / bruto	22,1 kg / 24,5 kg
Approximate output Producción aproximada	100 kg/h
HS code Partida arancelaria	84385000



ILLUSTRATIVE PHOTO. ACTUAL PRODUCTS AND ACCESSORIES MAY CHANGE.
FOTO ILUSTRATIVA. PRODUCTOS REALES Y ACCESORIOS PUEDEN CAMBIAR.



In Skymesen you can trust.
Si es Skymesen, puedes confiar.

13

www.skymesen.com





MEAT GRINDERS MOLINOS DE CARNES

MADE TO GRIND BONELESS BEEF/PORK.
PARA MOLER CARNE REFRIGERADA O NATURAL, SIN HUESO



BUTCHERY
CARNICERIA

PS10 / PS22

MEAT GRINDER 10, STAINLESS STEEL - MEAT GRINDER 22, STAINLESS STEEL
MOLINO DE CARNE 10, INOXIDABLE - MOLINO DE CARNE 22, INOXIDABLE



- Hardened structure in stainless steel
Construcción en acero inoxidable
- Gearbox with bronze buhing and o-ring sealing
Nueva caja de engranajes
- Robust
Robusto
- Easy cleaning
Fácil higienización

- Wider mouth for easier feeding
Boca de alimentación más ancha
- 5 mm disc included
Incluye disco 5mm
- New tray for higher productivity
Nueva bandeja



DISCO 3 mm
DISCO 8 mm

ACCESSORY SOLD SEPARATELY
ACCESORIO VENDIDO POR SEPARADO

MODEL / MODELO	PS10	PS22
Voltage / frequency / phases <i>Tensión eléctrica / frecuencia / fases</i>	110 V / 60 Hz / 1 220 V / 50 Hz / 1 220 V / 60 Hz / 1	110 V / 60 Hz / 1 220 V / 50 Hz / 1 220 V / 60 Hz / 1
Power rating <i>Potencia</i>	1 HP	2 HP
Dimensions (H x W x L) <i>Dimensiones (Al x An x L)</i>	530 x 325 x 710 mm	530 x 325 x 720 mm
Package size (H x W x L) <i>Dimensiones del embalaje (Al x An x L)</i>	495 x 415 x 800 mm	515 x 415 x 810 mm
Net / gross weight <i>Peso neto / bruto</i>	34,50 kg / 41,40 kg	40,00 kg / 47,50 kg
Approximate output <i>Producción aproximada</i>	200 kg/h	300 kg/h
HS code <i>Partida arancelaria</i>	84385000	84385000



ILLUSTRATIVE PHOTO. ACTUAL PRODUCTS AND ACCESSORIES MAY CHANGE.
FOTO ILUSTRATIVA. PRODUCTOS REALES Y LOS ACCESORIOS PUEDEN CAMBIAR.



In Skymesen you can trust.
Si es Skymesen, puedes confiar.

14

www.skymesen.com





MEAT GRINDERS MOLINOS DE CARNES

MADE TO GRIND BONELESS MEAT
PARA MOLER CARNE REFRIGERADA O NATURAL, SIN HUESO



BUTCHERY
CARNICERIA

PSP98 M

MEAT GRINDER 98, STAINLESS STEEL
MOLINO DE CARNE 98, INOXIDABLE



- ✓ Robust design
Nuevo diseño
- ✓ Cast iron mouth with thin coating
Boca de hierro fundido con baño de estano
- ✓ 5 mm disc included
Incluye disco de 5 mm
- ✓ Unger B98 System
Sistema Unger B98
- ✓ 2 HP power rating
Potencia 2 HP
- ✓ High capacity tray ON / OFF Switch in new location
Llave ON / OFF con nueva ubicación
- ✓ With pre-cutter
Con precortador
- ✓ New tray
Nueva bandeja



3 mm DISC - 8 mm DISC
DISCO de 3 mm - DISCO de 8 mm
ACCESSORY SOLD SEPARATELY
ACCESORIO VENDIDO POR SEPARADO



BPF98CPI STAINLESS STEEL MOUTH 98 PROFIX:
MORE HYGIENE AND DURABILITY
BPF98CPI BOCA COMPLETA 98 CP INOXIDABLE
PROFIX: MÁS HIGIENE Y DURABILIDAD
ACCESSORY SOLD SEPARATELY
ACCESORIO VENDIDO POR SEPARADO



MODEL / MODELO	PSP98 M
Voltage / frequency / phases Tensión eléctrica / frecuencia / fases	110 V / 60 Hz / 1 220 V / 50 Hz / 1 220 V / 60 Hz / 1
Power rating Potencia	2 HP
Consumption Consumo	1,47 kW
Dimensions (H x W x L) Dimensiones (Al x An x L)	590 x 400 x 850 mm
Package size (H x W x L) Dimensiones del embalaje (Al x An x L)	680 x 520 x 980 mm
Net / gross weight Peso neto / bruto	61,50 kg / 76,00 kg
Approximate output Producción aproximada	450 kg/h
HS code Partida arancelaria	84385000



PSP98 M
WEBSITE



PSP98 M
SITIO WEB

ILLUSTRATIVE PHOTO. ACTUAL PRODUCTS AND ACCESSORIES MAY CHANGE.
FOTO ILUSTRATIVA. PRODUCTOS REALES Y LOS ACCESORIOS PUEDEN CAMBIAR.



In Skymesen you can trust.
Si es Skymesen, puedes confiar.

15

www.skymesen.com



BRAZILIAN INDUSTRY
INDUSTRIA BRASILEÑA



MEAT GRINDERS WITH FIXED PROTECTION WITH STAINLESS STEEL MOUTH
MOLINOS DE CARNES CON PROTECCIÓN FIJA CON BOCA COMPLETA INOXIDABLE



MADE TO GRIND BONELESS BEEF/PORK.
 PARA MOLER CARNE REFRIGERADA O NATURAL, SIN HUESO.

BUTCHERY
 CARNICERÍA

PS22L

MEAT GRINDER 22, STAINLESS STEEL WITH STAINLESS STEEL MOUTH
 MOLINO DE CARNE 22, INOXIDABLE CON BOCA INOXIDABLE

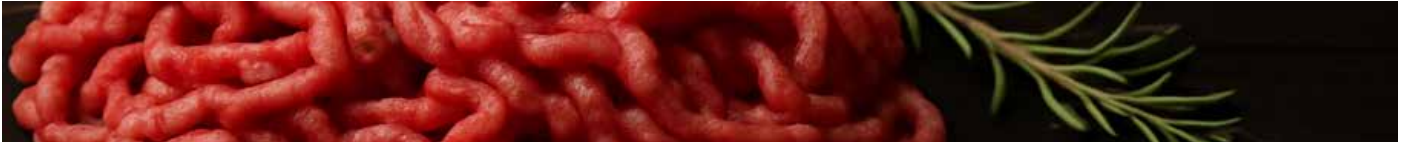

- ✓ **Hardened structure in stainless steel**
 Construcción en acero inoxidable
- ✓ **Gearbox with bronze bushing and o-ring sealing**
 Nueva caja de engranajes
- ✓ **Robust**
 Robusto
- ✓ **Easy cleaning**
 Fácil higienización
- ✓ **Larger tray for higher productivity**
 Nueva bandeja para alta productividad
- ✓ **Wider mouth for easier feeding**
 Boca de alimentación más ancha
- ✓ **Stainless steel 5 mm disc included**
 Disco de 5 mm incluido



DISCO 3 mm
DISCO 8 mm
 ACCESSORY SOLD SEPARATELY
 ACCESORIO VENDIDO POR SEPARADO



MODEL / MODELO	PS22L
Voltage / frequency / phases Tensión eléctrica / frecuencia / fases	110 V / 60 Hz / 1 220 V / 50 Hz / 1 220 V / 60 Hz / 1
Power rating Potencia	2 HP
Consumption Consumo	1,47 kW
Dimensions (H x W x L) Dimensiones (Al x An x L)	530 x 325 x 720 mm
Package size (H x W x L) Dimensiones del embalaje (Al x An x L)	515 x 415 x 810 mm
Net / gross weight Peso neto / bruto	40,00 kg / 47,50 kg
Approximate output Producción aproximada	300 kg/h
HS code Partida arancelaria	84385000



PS22L
 WEBSITE



PS22L
 SITIO WEB

ILLUSTRATIVE PHOTO. ACTUAL PRODUCTS AND ACCESSORIES MAY CHANGE.
 FOTO ILUSTRATIVA. PRODUCTOS REALES Y LOS ACCESORIOS PUEDEN CAMBIAR.



In Skymssen you can trust.
 Si es Skymssen, puedes confiar.



MEAT GRINDERS WITH FIXED PROTECTION WITH STAINLESS STEEL MOUTH
MOLINOS DE CARNES CON PROTECCIÓN FIJA CON BOCA COMPLETA INOXIDABLE

MADE TO GRIND BONELESS BEEF/PORK.
 PARA MOLER CARNE REFRIGERADA O NATURAL, SIN HUESO.



BUTCHERY
CARNICERÍA

PSP98LM

MEAT GRINDER 98, STAINLESS STEEL, WITH STAINLESS STEEL MOUTH
 MOLINO DE CARNE 98, INOXIDABLE CON BOCA INOXIDABLE



- ✓ **Hardened structure in stainless steel**
 Construcción en acero inoxidable
- ✓ **Gearbox with bronze bushing and o-ring sealing**
 Nueva caja de engranajes
- ✓ **High durability**
 Alta durabilidad
- ✓ **Easy cleaning**
 Fácil higienización
- ✓ **Larger tray for higher productivity**
 Nueva bandeja para alta productividad
- ✓ **Wider mouth for easier feeding**
 Boca de alimentación más ancha
- ✓ **Stainless steel 5 mm disc included**
 Disco de 5 mm incluido



DISCO 3 mm
DISCO 8 mm
 ACCESSORY SOLD SEPARATELY
 ACCESORIO VENDIDO POR SEPARADO

DOUBLE CUT KNIFE AND PRE-CUTTER INCLUDED
CUCHILLA DOBLE CORTE Y DISCO PRE CORTADOR INCLUIDO

MODEL / MODELO	PSP98LM
Voltage / frequency / phases <i>Tensión eléctrica / frecuencia / fases</i>	110 V / 60 Hz / 1 220 V / 50 Hz / 1 220 V / 60 Hz / 1
Power rating <i>Potencia</i>	2 HP
Dimensions (H x W x L) <i>Dimensiones (Al x An x L)</i>	590 x 400 x 850 mm
Package size (H x W x L) <i>Dimensiones del embalaje (Al x An x L)</i>	680 x 520 x 980 mm
Net / gross weight <i>Peso neto / bruto</i>	65,80 kg / 80,30 kg
Approximate output <i>Producción aproximada</i>	450 kg/h
HS code <i>Partida arancelaria</i>	84385000



ILLUSTRATIVE PHOTO. ACTUAL PRODUCTS AND ACCESSORIES MAY CHANGE.
 FOTO ILUSTRATIVA. PRODUCTOS REALES Y LOS ACCESORIOS PUEDEN CAMBIAR.



In Skymesen you can trust.
 Si es Skymesen, puedes confiar.



HOMOGENIZERS HOMOGENEIZADORES

THEY MIX AND GRIND LARGE QUANTITIES OF MEAT, INCREASING PRODUCTIVITY, MAKING THE MEAT MORE HOMOGENEOUS, AND REDUCING VISIBLE FAT.
MEZCLAN Y MUELEN GRANDES CANTIDADES DE CARNE, AUMENTANDO LA PRODUCTIVIDAD, HACIENDO LA CARNE MÁS HOMOGÉNEA Y REDUCIENDO LA GRASA APARENTE



BUTCHERY
CARNICERÍA

HS-22SC / HS-22CC

Stainless Steel Meat Grinder Homogenizers, #22 Stainless Steel Head Without Stand and #22 Stainless Steel Head, With Stand.
Moldeadores Homogeneizadores de Carne de Acero Inoxidable, Boca 22 de Acero Inoxidable, Sin Soporte y Boca 22 de Acero Inoxidable, Con Soporte.



PERFECT MEAT IN SECONDS CARNES PERFECTAS EN SEGUNDOS

With a compact size and high power, it delivers much more productivity. Its automatic operation makes the process faster and safer, and the homogenization system adds value to the product, making it essential for self-service sales. Ideal para preparar mezclas para chorizo, hamburguesas y carne de ave condimentada.

Con un tamaño compacto y gran potencia, ofrece mucha más productividad. Su funcionamiento automático hace que el proceso sea más rápido y seguro, y el sistema de homogeneización agrega valor al producto, siendo indispensable para la venta en autoservicio.

✓ Stainless steel construction
Construcción en acero inoxidable

✓ Micro-cast stainless steel head and worm
Boca y sinfín en acero inoxidable microfundido

✓ Safety sensor on the lid
Sensor de seguridad en la tapa

✓ 16 kg capacity hopper
Tolva con capacidad de 16 kg

✓ Intuitive control panel
Panel intuitivo

✓ Includes 3 mm and 5 mm discs
Incluye discos de 3 mm y 5 mm



8 mm DISC
DISCO 8 mm

ACCESSORY SOLD SEPARATELY
ACCESORIO VENDIDO POR SEPARADO



Tray support included
model HS22CC

Soporte para bandeja
incluido modelo HS22CC

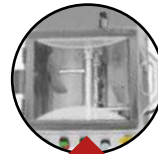

Transparent lid for
internal viewing

Tapa transparente para
visualización interna



Foot pedal activation
on both models

Pedal de accionamiento
en ambos modelos.

PATENTED
PATENTADO



Foot pedal activation
on both models

Pedal de accionamiento
en ambos os modelos

MODEL / MODELO	HS-22SC	HS-22CC
Voltage / frequency / phases Tensión eléctrica / frecuencia / fases	220 V / 60 Hz / 1 220 V / 60 Hz / 3 380 V / 60 Hz / 3	220 V / 60 Hz / 1 220 V / 60 Hz / 3 380 V / 60 Hz / 3
Power rating Potencia	1472-246 W	1472-246 W
Motor power Potencia del motor	2 – 0,33 HP-CV	2 – 0,33 HP-CV
Consumption Consumo	1,72 KW/h	1,72 KW/h
Dimensions (H x W x L) Dimensiones (Al x An x L)	625 x 480 x 990 mm	1255 x 480 x 990 mm
Package size (H x W x L) Dimensiones del embalaje (Al x An x L)	800 x 585 x 1160 mm	1460 x 579 x 1154 mm
Net / gross weight Peso neto / bruto	96 kg / 121 kg	115 kg / 146 kg
Approximate output Producción aproximada	600 kg/h	600 kg/h
Hopper Capacity Capacidad de la Tolva	22 L / 16 kg	22 L / 16 kg
HS code Partida arancelaria	84385000	84385000



HS-22SC
WEBSITE



HS-22CC
WEBSITE



HS-22SC
SITIO WEB



HS-22CC
SITIO WEB



In Skymssen you can trust.
Si es Skymssen, puedes confiar.

18

www.skymssen.com



ILLUSTRATIVE PHOTO. ACTUAL PRODUCTS AND ACCESSORIES MAY CHANGE.
FOTO ILUSTRATIVA. PRODUCTOS REALES Y ACCESORIOS PUEDEN CAMBIAR.



MEAT GRINDERS MOLINOS DE CARNES

MADE TO GRIND BONELESS MEAT
PARA MOLER CARNE REFRIGERADA O NATURAL, SIN HUESO



BUTCHERY
CARNICERÍA

HS-98

MEAT GRINDER 98, STAINLESS STEEL
MOLINO DE CARNE 98, INOXIDABLE



MORE THAN A MEAT GRINDER MÁS QUE UN MOLINO DE CARNE

Perfect for those who work with trays and self-service counters. Adds quality and productivity.

Perfecto para quienes trabajan con bandejas y mostradores de autoservicio y cadenas de hamburguesas. Añade calidad y productividad.

- ✓ Grind faster
Moler más rápido
- ✓ Improve product presentation
Mejor la presentación del producto
- ✓ 3 mm and 5 mm discs included
Discos de 3 mm y 5 mm inclusos
- ✓ Leaves the operator free for other tasks
Deja el operador libre para otras tareas
- ✓ Reduces apparent fat
Perfecta mezcla de grasa

PATENTED
PATENTADO



Foot pedal activation
on both models
*Pedal de accionamiento
en ambos os modelos*



Robust and durable, all
stainless steel
*Robusto y duradero, todo de
acero inoxidable*



Stand with drawer
to hold boxes
*Caballote con cajón
para sujetar bandejas*



Security lock
system on the cover
*Switch de seguridad en
la tapa*



8 mm DISC
DISCO 8 mm
ACCESSORY SOLD SEPARATELY
ACCESORIO VENDIDO POR SEPARADO

FOOT PEDAL SWITCH
PEDAL POSICIONADOR INCLUSO

MODEL / MODELO	HS-98
Voltage / frequency / phases <i>Tensión eléctrica / frecuencia / fases</i>	220 V / 50 Hz / 3 220 V / 60 Hz / 3 380 V / 50 Hz / 3 380 V / 60 Hz / 3
Power rating <i>Potencia</i>	3-0,5 HP
Dimensions (H x W x L) <i>Dimensiones (Al x An x L)</i>	1.300 x 520 x 1.200 mm
Package size (H x W x L) <i>Dimensiones del embalaje (Al x An x L)</i>	1.500 x 680 x 1.330 mm
Net / gross weight <i>Peso neto / bruto</i>	183,00 kg / 203,00 kg
Approximate output <i>Producción aproximada</i>	900 kg/h
Hopper Capacity <i>Capacidad de la Tolva</i>	41 L / 31 kg
HS code <i>Partida arancelaria</i>	84385000



HS-98
WEBSITE



HS-98
SITIO WEB

ILLUSTRATIVE PHOTO. ACTUAL PRODUCTS AND ACCESSORIES MAY CHANGE.
FOTO ILUSTRATIVA. PRODUCTOS REALES Y ACCESORIOS PUEDEN CAMBIAR.



In Skymesen you can trust.
Si es Skymesen, puedes confiar.

19

www.skymesen.com



BRAZILIAN INDUSTRY
INDUSTRIA BRASILEÑA



TABLE BAND SAWS SIERRAS DE BANCADA PARA HUESOS

TABLE BAND SAWS FOR CUTTING SMALLER PORTIONS OF MEAT WITHOUT BONES
SIERRAS PARA CORTAR CARNE CON HUESO, PESCADO O AVES, HASTA -5°C.



BUTCHERY
CARNICERÍA

SB / SBL

TABLE BAND SAW, BLADE 1.740 MM / 68,5" - TABLE BAND SAW, STAINLESS STEEL, WITH CUT - REGULATOR, BLADE 1.740 MM / 68,5"
SIERRA DE BANCADA PARA HUESOS, CINTA 1.740 MM / 68,5" - SIERRA DE BANCADA PARA HUESOS, INOXIDABLE, CON REGULADOR DE CORTE, CINTA 1.740 MM / 68,5"



SB

PERFECT SIZE TAMAÑO IDEAL

Compact and powerful saws, ideal for butcheries, mini markets, steakhouses and similars.

Sierras compactas y potentes, ideales para carnicerías, pescaderías, asadores de carne y otros

- High cutting speed: 600 m/min
Alta velocidad de corte: 600 m/min
- Safety system
Sistema de seguridad
- Large stationary table
Mesa fija amplia



SBL

DOOR WITH MAGNETIC LOCK CIERRE MAGNÉTICO

- Painted carbon steel structure
Estructura de acero carbono pintado

- Includes one blade on the machine and an extra blade as a spare
Una cinta incorporada y otra para repuesto

- Stainless steel structure
Estructura de acero inoxidable

MODEL / MODELO	SB	SBL
Voltage / frequency / phases Tensión eléctrica / frecuencia / fases	110V / 60 Hz / 1 220 V / 50 Hz / 1 220 V / 60 Hz / 1	110V / 60 Hz / 1 220 V / 50 Hz / 1 220 V / 60 Hz / 1
Power rating Potencia	0,75 HP	0,75 HP
Dimensions (H x W x L) Dimensiones (Al x An x L)	895 x 550 x 520 mm	895 x 550 x 520 mm
Package size (H x W x L) Dimensiones del embalaje (Al x An x L)	1.070 x 625 x 675 mm	1.070 x 625 x 675 mm
Net / gross weight Peso neto / bruto	37,40 kg / 53,70 kg	37,40 kg / 53,70 kg
Cutting clearance (HxW) Área de corte (Al x An)	170 x 170 mm	170 x 170 mm
Table dimensions (WxL) Dimensiones de la mesa (An x L)	450 x 500 mm	450 x 500 mm
Blade length Longitud de la cinta	1.740 mm	1.740 mm
Blade speed Velocidad de la cinta	600 m/min 500 m/min 600 m/min	600 m/min 500 m/min 600 m/min
HS code Partida arancelaria	84659190	84659190



ILLUSTRATIVE PHOTO. ACTUAL PRODUCTS AND ACCESSORIES MAY CHANGE.
FOTO ILUSTRATIVA. PRODUCTOS REALES Y LOS ACCESORIOS PUEDEN CAMBIAR.



In Skymesen you can trust.
Si es Skymesen, puedes confiar.



BAND SAWS SIERRAS PARA HUESOS

DESIGNED TO MAKE PRECISE CUTS OF DIFFERENT MEATS, AND MEAT WITH BONE.
SIERRAS PARA CORTAR CARNE CON HUESO, PESCADO O AVES, HASTA -5°C



BUTCHERY
CARNICERIA

SF-218 / SL-218

BAND SAW, WITH CUT REGULATOR, BLADE 2.180 mm / 86" BAND SAW, STAINLESS STEEL, CUT REGULATOR, BLADE 2.180 mm / 86"
SIERRA PARA HUESOS, CON REGULADOR DE CORTE, CINTA 2.180 mm / 86" SIERRA PARA HUESOS, INOXIDABLE, REGULADOR DE CORTE, CINTA 2.180 mm / 86"



- ✓ Blade length: 2.180 mm (86")
Longitud de la cinta: 2.180 mm (86")
- ✓ Powerful 1,5 HP motor
Potencia del motor de 1,5 HP
- ✓ Removable door for easy cleaning
Puerta removible para fácil higienización
- ✓ Wheel and blade scrapers
Limpiadores de cinta y volante
- ✓ Cut regulator
Regulador espesor de corte
- ✓ Low maintenance cost
Bajo costo de mantenimiento
- ✓ One blade on the machine and an extra blade for spare
Una cinta incorporada y otra para repuesto

STATIONARY TABLE MESA FIJA



MODEL / MODELO	SF-218	SL-218
Voltage / frequency / phases Tensión eléctrica / frecuencia / fases	110V / 60 Hz / 1 220 V / 50 Hz / 1 220 V / 60 Hz / 1	110V / 60 Hz / 1 220 V / 50 Hz / 1 220 V / 60 Hz / 1
Power rating Potencia	1,5 HP	1,5 HP
Dimensions (H x W x L) Dimensiones (Al x An x L)	1.540 x 630 x 645 mm	1.540 x 630 x 645 mm
Package size (H x W x L) Dimensiones del embalaje (Al x An x L)	1.700 x 740 x 750 mm	1.700 x 740 x 750 mm
Net / gross weight Peso neto / bruto	56,00 kg / 83,00	56,00 kg / 83,00
Cutting clearance (HxW) Área de corte (Al x An)	230 x 190 mm	230 x 190 mm
Table dimensions (WxL) Dimensiones de la mesa (An x L)	570 x 600 mm	570 x 600 mm
Blade length Longitud de la cinta	2.180 mm	2.180 mm
Blade speed Velocidad de la cinta	900 m/min 700 m/min 900 m/min	901 m/min 700 m/min 900 m/min
HS code Partida arancelaria	84659190	84659190



SF-218
WEBSITE



SL-218
WEBSITE



SF-218
SITIO WEB



SL-218
SITIO WEB

ILLUSTRATIVE PHOTO. ACTUAL PRODUCTS AND ACCESSORIES MAY CHANGE.
FOTO ILUSTRATIVA. PRODUCTOS REALES Y LOS ACCESORIOS PUEDEN CAMBIAR.



In Skymesen you can trust.
Si es Skymesen, puedes confiar.

21

www.skymesen.com



BRAZILIAN INDUSTRY
INDUSTRIA BRASILEÑA



BAND SAWS SIERRAS PARA HUESOS

DESIGNED TO MAKE PRECISE CUTS OF DIERENT MEATS, AND MEAT WITH BONE.
SIERRA DISEÑADA PARA CORTAR CON PRECISIÓN VARIOS TIPOS DE CARNES, AL NATURAL O CONGELADAS HASTA -5°C.



BUTCHERY
CARNICERÍA

SF-282 / SL-282

BAND SAW, WITH MOVABLE TABLE, CUT REGULATOR, BLADE 2.820 mm / 111" BAND SAW, STAINLESS STEEL, WITH MOVABLE TABLE, CUT REGULATOR, BLADE 2.820 mm / 111"
SIERRA PARA HUESOS, CON MESA MÓVIL, REGULADOR DE CORTE, CINTA 2.820 mm / 111" SIERRA PARA HUESOS, INOXIDABLE, CON MESA MÓVIL, REGULADOR DE CORTE, CINTA 2.820 mm / 111"



- ✓ Available in two versions: SF-282 (Epoxy painted carbon steel structure) and SL-282 (Stainless steel structure)
Disponibile en dos versiones: SF-282 (acero carbono pintura epóxica) y SL-282 (acero inoxidable)
- ✓ Removable door for easy cleaning
Puerta removible para fácil higienización
- ✓ Wheel and blade scrappers
Limpiadores de cinta y volante
- ✓ Cut regulator
Regulador espesor de corte
- ✓ 2820 mm (111") blade with 6 teeth per inch
Cinta de banda 2.820 mm (111") con 6 dientes por pulgada
- ✓ Powerful 2 HP motor
Potente motor de 2 HP
- ✓ Since august/2024 the blade speed was increased
Desde agosto/2024 aumentado la velocidad de la cinta

**SLIDING TABLE
(REMOVABLE FOR CLEANING)
MESA MÓVIL
REMOVABLE DOOR FOR EASY**



MODEL / MODELO	SF-282	SL-282
Voltage / frequency / phases <i>Tensión eléctrica / frecuencia / fases</i>	110V / 60 Hz / 1 220 V / 50 Hz / 1 220 V / 60 Hz / 1	110V / 60 Hz / 1 220 V / 50 Hz / 1 220 V / 60 Hz / 1
Power rating <i>Potencia</i>	2 HP	2 HP
Dimensions (H x W x L) <i>Dimensiones (Al x An x L)</i>	1.675 x 850 x 870 mm	1.675 x 850 x 870 mm
Package size (H x W x L) <i>Dimensiones del embalaje (Al x An x L)</i>	1.910 x 1.030 x 1.030 mm	1.910 x 1.030 x 1.030 mm
Net / gross weight <i>Peso neto / bruto</i>	75,00 kg / 102,00 kg	75,00 kg / 101,00 kg
Cutting clearance (HxW) <i>Área de corte (Al x An)</i>	380 x 230 mm	380 x 230 mm
Table dimensions (WxL) <i>Dimensiones de la mesa (An x L)</i>	695 x 805 mm	695 x 805 mm
Blade length <i>Longitud de la cinta</i>	2.820 mm	2.820 mm
Blade speed <i>Velocidad de la cinta</i>	900 m/min (15 m/s) 800 m/min (13 m/s) 900 m/min (15 m/s)	900 m/min (15 m/s) 800 m/min (13 m/s) 900 m/min (15 m/s)
HS code <i>Partida arancelaria</i>	84659190	84659190



SF-282
WEBSITE



SL-282
WEBSITE



SF-282
SITIO WEB



SL-282
SITIO WEB

ILLUSTRATIVE PHOTO. ACTUAL PRODUCTS AND ACCESSORIES MAY CHANGE.
FOTO ILUSTRATIVA. PRODUCTOS REALES Y LOS ACCESORIOS PUEDEN CAMBIAR.



In Skymssen you can trust.
Si es Skymssen, puedes confiar.

22

www.skymssen.com



BRAZILIAN INDUSTRY
INDUSTRIA BRASILEIRA



BAND SAWS SIERRAS PARA HUESOS

DESIGNED TO MAKE PRECISE CUTS OF DIFFERENT MEATS, AND MEAT WITH BONE.
SIERRA DISEÑADA PARA CORTAR CON PRECISIÓN VARIOS TIPOS DE CARNES CON HUESO, AL NATURAL O CONGELADAS HASTA -5°C.



BUTCHERY
CARNICERÍA

SF-295 / SL-295

BAND SAW, WITH MOVABLE TABLE, CUT REGULATOR, BLADE 2.950 mm / 116" BAND SAW, STAINLESS STEEL, WITH MOVABLE TABLE, CUT REGULATOR, BLADE 2.950 mm / 116"
SIERRA PARA HUESOS, CON MESA MÓVIL, REGULADOR DE CORTE, CINTA 2.950 mm / 116" SIERRA PARA HUESOS, INOXIDABLE, CON MESA MÓVIL, REGULADOR DE CORTE, INTA 2.950 mm / 116"



- ✓ Removable door for easy cleaning
Puerta removible para fácil higienización
- ✓ Wheel and blade scrappers
Limpiadores de cinta y volante
- ✓ Cut regulator
Regulador espesor de corte
- ✓ 2.950 mm (116") blade with 3 teeth per inch
*Cinta de banda 2.950 mm (116")
con 3 dientes por pulgada*
- ✓ Powerful 2 HP motor
Potente motor de 2 HP
- ✓ Sliding Table
Mesa móvil
- ✓ Since august/2024 the blade speed was increased
*Desde agosto/2024 aumentado la
velocidade de la cinta*



MODEL / MODELO	SF-295	SL-295
Voltage / frequency / phases <i>Tensión eléctrica / frecuencia / fases</i>	110V / 60 Hz / 1 220 V / 50 Hz / 1 220 V / 60 Hz / 1	110V / 60 Hz / 1 220 V / 50 Hz / 1 220 V / 60 Hz / 1
Power rating <i>Potencia</i>	2 HP	2 HP
Dimensions (H x W x L) <i>Dimensiones (Al x An x L)</i>	1.740 x 850 x 870 mm	1.740 x 850 x 870 mm
Package size (H x W x L) <i>Dimensiones del embalaje (Al x An x L)</i>	1.910 x 1.030 x 1.030 mm	1.910 x 1.030 x 1.030 mm
Net / gross weight <i>Peso neto / bruto</i>	75,00 kg / 102,00 kg	75,00 kg / 101,00 kg
Cutting clearance (HxW) <i>Área de corte (Al xAn)</i>	440 x 230 mm	440 x 230 mm
Table dimensions (WxL) <i>Dimensiones de la mesa (An x L)</i>	695 x 805 mm	695 x 805 mm
Blade length <i>Longitud de la cinta</i>	2.950 mm	2.950 mm
Blade speed <i>Velocidad de la cinta</i>	900 m/min (15 m/s) 800 m/min (13 m/s) 900 m/min (15 m/s)	900 m/min (15 m/s) 800 m/min (13 m/s) 900 m/min (15 m/s)
HS code <i>Partida arancelaria</i>	84659190	84659190



SF-295
WEBSITE



SL-295
WEBSITE



SF-295
SITIO WEB



SL-295
SITIO WEB

ILLUSTRATIVE PHOTO. ACTUAL PRODUCTS AND ACCESSORIES MAY CHANGE.
FOTO ILUSTRATIVA. PRODUCTOS REALES Y LOS ACCESORIOS PUEDEN CAMBIAR.



In Skymssen you can trust.
Si es Skymssen, puedes confiar.

23

www.skymssen.com



BRAZILIAN INDUSTRY
INDUSTRIA BRASILEIRA



BAND SAWS SIERRAS PARA HUESOS

DESIGNED TO CUT MEAT AND MEAT WITH BONE.
DISEÑADO PARA REALIZAR CORTES PRECISOS DE DIFERENTES CARNES.



BUTCHERY
CARNICERÍA

SFL-282 HD / SFL-295 HD

BAND SAW, STAINLESS STEEL, WITH MOVABLE TABLE, CUT REGULATOR, BLADE 2.820 mm (111") / 2.950 mm (116"), HEAVY DUTY
SIERRA PARA HUESOS, INOXIDABLE, CON MESA MÓVIL, REGULADOR DE CORTE, CINTA 2.820mm (111") / 2.950 mm (116"), HEAVY DUTY

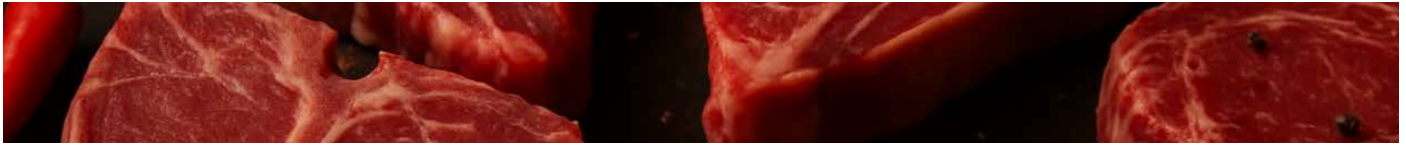

- ✓ Motor 2HP
Motor 2HP
- ✓ Door with safety system
Puerta con sensores de seguridad
- ✓ Hardened structure
Construcción en acero inoxidable
- ✓ Wheel and blade scrapers
Limpiadores de cinta y volante
- ✓ Handle for cutting height adjustment
Ajuste de la altura de corte
- ✓ Large table and cutting clearance
Mesa y área de corte de grande dimensión
- ✓ Movable table with smooth sliding and lock
Mesa móvil con deslizamiento suave y traba
- ✓ Removable door
Puerta removible
- ✓ Easy cleaning
Fácil limpieza



Easy blade
tension control
*Fácil calibrado
tensión de la cinta*

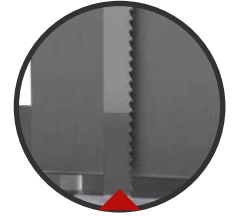

BLADE CINTA BANDA

4 teeth per inch
(SFL-282HD)
3 teeth per inch
(SFL-295HD)

4 dientes por pulgada
(SFL-282HD)
3 dientes por pulgada
(SFL-295HD)



MODEL / MODELO	SFL-282HD	SFL-295HD
Voltage / frequency / phases <i>Tensión eléctrica / frecuencia / fases</i>	110V / 60 Hz / 1 220 V / 50 Hz / 1 220 V / 60 Hz / 1	110V / 60 Hz / 1 220 V / 50 Hz / 1 220 V / 60 Hz / 1
Power rating <i>Potencia</i>	2 HP	2 HP
Dimensions (H x W x L) <i>Dimensiones (Al x An x L)</i>	1.900 x 900 x 980 mm	1.965 x 900 x 980 mm
Package size (H x W x L) <i>Dimensiones del embalaje (Al x An x L)</i>	2.110 x 1.080 x 1.100 mm	2.110 x 1.080 x 1.100 mm
Net / gross weight <i>Peso neto / bruto</i>	129,00 kg / 178,00 kg	132,00 kg / 181,00 kg
Cutting clearance (HxW) <i>Área de corte (Al xAn)</i>	350 x 330 mm	410 x 330 mm
Table dimensions (WxL) <i>Dimensiones de la mesa (An x L)</i>	870 x 810 mm	870 x 810 mm
Blade length <i>Longitud de la cinta</i>	2.820 mm	2.950 mm
Blade speed <i>Velocidad de la cinta</i>	900 m/min (15 m/s) 700 m/min (12 m/s) 900 m/min (15 m/s)	900 m/min (15 m/s) 700 m/min (12 m/s) 900 m/min (15 m/s)
HS code <i>Partida arancelaria</i>	84659190	84659190



SFL-282HD
WEBSITE



SFL-295HD
WEBSITE



SFL-282HD
SITIO WEB



SFL-295HD
SITIO WEB

ILLUSTRATIVE PHOTO. ACTUAL PRODUCTS AND ACCESSORIES MAY CHANGE.
FOTO ILUSTRATIVA. PRODUCTOS REALES Y LOS ACCESORIOS PUEDEN CAMBIAR.



In Skymesen you can trust.
Si es Skymesen, puedes confiar.

24

www.skymesen.com



BRAZILIAN INDUSTRY
INDUSTRIA BRASILEIRA



BAND SAWS MOLINOS DE CARNES

MADE TO GRIND BONELESS MEAT
PARA MOLER CARNE REFRIGERADA O NATURAL, SIN HUESO



BUTCHERY
CARNICERÍA

SFL-315HD

BAND SAW, STAINLESS STEEL, WITH MOVABLE TABLE, CUT REGULATOR, BLADE 3.150 / (124"), HEAVY DUTY
SIERRA PARA HUESOS, INOXIDABLE, CON MESA MÓVIL, REGULADOR DE CORTE, CINTA 3.150mm / (124"), HEAVY DUTY



- ✓ Motor 2HP
Motor 2HP
- ✓ Door with safety system
Puerta con sensores de seguridad
- ✓ Hardened structure
Construcción en acero inoxidable
- ✓ Wheel and blade scrapers
Limpiadores de cinta y volante
- ✓ Handle for cutting height adjustment
Ajuste de la altura de corte
- ✓ Large table and cutting clearance
Mesa y área de corte de grande dimensión
- ✓ Movable table with smooth sliding and lock
Mesa móvil con deslizamiento suave y traba
- ✓ Removable door
Puerta removible
- ✓ Easy cleaning
Fácil limpieza

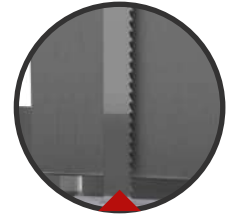

BLADE CINTA BANDA

4 teeth per inch
4 dientes por pulgada



Easy blade
tension control
Fácil calibrado
tension de la cinta

MODEL / MODELO	SFL-315HD
Voltage / frequency / phases <i>Tensión eléctrica / frecuencia / fases</i>	110V / 60 Hz / 1 220 V / 50 Hz / 1 220 V / 60 Hz / 1
Power rating <i>Potencia</i>	2 HP
Dimensions (H x W x L) <i>Dimensiones (Al x An x L)</i>	2.000 x 970 x 1.050 mm
Package size (H x W x L) <i>Dimensiones del embalaje (Al x An x L)</i>	2.100 x 1.090 x 1.170 mm
Net / gross weight <i>Peso neto / bruto</i>	141,00 kg / 204,00 kg
Cutting clearance (HxW) <i>Área de corte (Al x An)</i>	380 x 380 mm
Table dimensions (WxL) <i>Dimensiones de la mesa (An x L)</i>	930 x 880 mm
Blade length <i>Longitud de la cinta</i>	3.150 mm
Blade speed <i>Velocidad de la cinta</i>	900 m/min (15 m/s) 700 m/min (12 m/s) 900 m/min (15 m/s)
HS code <i>Partida arancelaria</i>	84659190



SFL-315HD
WEBSITE



SFL-315HD
SITIO WEB

ILLUSTRATIVE PHOTO. ACTUAL PRODUCTS AND ACCESSORIES MAY CHANGE.
FOTO ILUSTRATIVA. PRODUCTOS REALES Y LOS ACCESORIOS PUEDEN CAMBIAR.



In Skymesen you can trust.
Si es Skymesen, puedes confiar.

25

www.skymesen.com



BRAZILIAN INDUSTRY
INDUSTRIA BRASILEIRA



SLICER - CORTADORA DE FIAMBRES

For slicing cold cuts, we offer a complete line of automatic and semi-automatic slicers. These are robust, efficient, and easy-to-clean machines, equipped with safety devices to ensure secure operation.

Para el corte de fiambres, ofrecemos una línea completa de cortadoras automáticas y semiautomáticas. Son equipos robustos, eficientes y fáciles de limpiar, equipados con dispositivos de seguridad que garantizan un uso seguro.



AUTOMATIC SLICER CORTADORAS DE FIAMBRES AUTOMÁTICAS

THEY SLICE CHEESES AND SAUSAGES WITH PRECISION, FEATURE A POWERFUL MOTORIZED BLADE AND A SMOOTH AUTOMATIC SLIDING CAR.
CORTA CON PRECISIÓN QUESOS Y FIAMBRES, CON CUCHILLA MOTORIZADA Y DESLIZAMIENTO AUTOMÁTICO DEL CARRO.



SLICER
CORTADOR DE
FIAMBRES

FA-300

SLICER, STAINLESS STEEL, BLADE 300 mm
CORTADORA DE FIAMBRES, INOXIDABLE, CUCHILLA 300 mm



PRECISION AND UNIFORMITY PRECISIÓN Y UNIFORMIDAD

Manufactured to a high standard, providing easy cleaning and great durability, reducing the amount of waste from processed products.

Fabricados con un alto estándar, proporcionando una fácil limpieza y gran durabilidad, reduciendo la cantidad de desperdicios de los productos procesados.

- Resistant and durable
Resistente y duradero
- 38 slices per minute
38 rebanadas por minuto
- High cutting quality
Alta calidad de corte
- Aluminum and stainless steel structure
Estructura de aluminio y acero inoxidable
- Extremely thin slices from 0 to 3 mm
ebanadas extremadamente finas hasta 3 mm



FRONT VIEW
VISTA FRONTAL



SHARPENING
SISTEMA DE AFILADO



SIDE VIEW
VISTA LATERAL

BLADE MADE WITH
GERMAN TECHNOLOGY
CUCHILLA CON TECNOLOGÍA
ALEMÁN

MODEL / MODELO	FA-300
Voltage / frequency / phases <i>Tensión eléctrica / frecuencia / fases</i>	110 V / 60 Hz / 1 220 V / 50 Hz / 1 220 V / 60 Hz / 1
Power rating <i>Potencia</i>	0,33 HP - CV
Dimensions (H x W x L) <i>Dimensiones (Al x An x L)</i>	645 x 610 x 660 mm
Package size (H x W x L) <i>Dimensiones del embalaje (Al x An x L)</i>	830 x 750 x 790 mm
Net / gross weight <i>Peso neto / bruto</i>	38,60 kg / 51,20 kg
Cutting dimensions (H x W) <i>Dimensiones de corte (Al x An)</i>	190 x 180 mm
Slices per minute <i>Rebanadas por minuto</i>	38
Disc diameter <i>Diámetro del disco</i>	300 mm
HS code <i>Partida arancelaria</i>	84385000



FA-300
WEBSITE



FA-300
SITIO WEB



In Skymssen you can trust.
Si es Skymssen, puedes confiar.

27

www.skymssen.com





BAR AND RESTAURANT - BAR Y RESTAURANTE

In our Bar and Restaurant line, we offer a wide range of essential equipment for the foodservice industry, ensuring efficient and safe production. In addition to a skilled team, some specific items are necessary to set up a bar or restaurant, such as: cutters, potato, onion, and garlic peelers, juice extractors, juice centrifuges, fryers, mixers, professional blenders, food processors, graters, pizza dough sheeters, deck ovens, and much more.

En nuestra línea de Bar y Restaurante, presentamos una amplia gama de equipos imprescindibles para el sector de foodservice, que garantizan una producción eficiente y segura. Además de un equipo de profesionales, algunos elementos específicos son necesarios para montar un bar o restaurante, tales como: cutters, peladoras de patatas, cebollas y ajos, extractores de zumos, centrifugadoras de zumos, freidoras, batidoras, licuadoras profesionales, procesadores de alimentos, ralladores, laminadoras de masa para pizza, hornos de solera y mucho más.



CUTTER PROCESADORA CUTTER

EFFICIENT AND ROBUST, THE CUTTER IS A VERSATILE TOOL THAT ALLOWS MULTIPLE KITCHEN PREPARATIONS.
ROBUSTO, EFICIENTE, ES DEFINITIVAMENTE EL AYUDANTE DE COCINA MÁS VERSÁTIL PARA TU NEGÓCIO.



BAR AND
RESTAURANT
BAR Y RESTAURANTE

CR-4L / CR-8L

STAINLESS STEEL CUTTER 4 AND 8 LITERS, SCRAPER (OPTIONAL)
CUTTER INOXIDABLE 4 Y 8 LITROS, BRAZO RASCADOR (OPCIONAL)



SAVE TIME IN YOUR KITCHEN AHORRA TIEMPO EN TU COCINA

The Cutter has plenty of power to grind meat and chop nuts and various types of vegetables. It also prepares pâtés, purées, spreads, sauces, and a wide variety of recipes.

El Cutter tiene potencia de sobra para picar carne y triturar frutos secos y diversos tipos de verduras. Además, también prepara patés, purés, pastas, salsas y una gran variedad de recetas.

✓ Scrapper Kit (optional)
Kit brazo rascador (opcional)

✓ Doser with plug allows the pouring of ingredients
Dosificador con tapa para agregar ingredientes

✓ Safety Sensor shuts down the machine when the lid is opened
Sensor de seguridad en la tapa

✓ Pulse Button
Tecla pulsar

✓ Stainless steel bowl
Olla de inoxidable

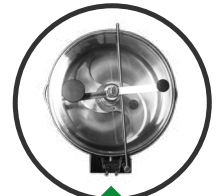

See-through lid
Tapa de policarbonato



Scrapper Kit (optional)
Kit rascador (opcional)



Cooked meat shredder blade (optional)

Cuchilla deshiladora de carnes (opcional)



Prepares Peanut Butter
Perfecto para hacer crema de maní



MODEL / MODELO	CR-4L	CR-8L
Voltage / frequency / phases <i>Tensión eléctrica / frecuencia / fases</i>	110V / 60 Hz / 1 220 V / 50 Hz / 1 220 V / 60 Hz / 1	110V / 60 Hz / 1 220 V / 50 Hz / 1 220 V / 60 Hz / 1
Power rating <i>Potencia</i>	0,5 HP	1 HP
Dimensions (H x W x L) <i>Dimensiones (Al x An x L)</i>	465 x 265 x 275 mm	525 x 320 x 335 mm
Package size (H x W x L) <i>Dimensiones del embalaje (Al x An x L)</i>	530 x 320 x 320 mm	600 x 360 x 380 mm
Net / gross weight <i>Peso neto / bruto</i>	15,25 kg / 16,40 kg	17,50 kg / 19,60 kg
Consumption <i>Consumo</i>	0,8 kW-h	1 kW-h
Rotation <i>Rotación</i>	1.750 rpm	1.750 rpm
HS code <i>Partida arancelaria</i>	84659190	84659190



CR-4L
WEBSITE



CR-8L
WEBSITE



CR-4L
SITIO WEB



CR-8L
SITIO WEB



In Skymesen you can trust.
Si es Skymesen, puedes confiar.

29

www.skymesen.com



ILLUSTRATIVE PHOTO. ACTUAL PRODUCTS AND ACCESSORIES MAY CHANGE.
FOTO ILUSTRATIVA. PRODUCTOS REALES Y LOS ACCESORIOS PUEDEN CAMBIAR.



CUTTER PROCESADORA CUTTER

EFFICIENT AND ROBUST, THE CUTTER IS A VERSATILE TOOL THAT ALLOWS MULTIPLE KITCHEN PREPARATIONS.
ROBUSTO, EFICIENTE, ES DEFINITIVAMENTE EL AYUDANTE DE COCINA MÁS VERSÁTIL PARA TU NEGOCIO



BAR AND
RESTAURANT
BAR Y RESTAURANTE

CR-4LR / CR-8LR

STAINLESS STEEL CUTTER 4 AND 8 LITERS WITH SCRAPER
CUTTER INOXIDABLE 4 Y 8 LITROS CON BRAZO RASCADOR



SAVE TIME IN YOUR KITCHEN AHORRA TIEMPO EN TU COCINA

The Cutter has plenty of power to grind meat and chop nuts and various types of vegetables. It also prepares pâtés, purées, spreads, sauces, and a wide variety of recipes.

El Cutter tiene potencia de sobra para picar carne y triturar frutos secos y diversos tipos de verduras. Además, también prepara patés, purés, pastas, salsas y una gran variedad de recetas.

- ✓ **Doser with plug allows the pouring of ingredients**
Dosificador con tapa para agregar ingredientes
- ✓ **Safety Sensor shuts down the machine when the lid is opened**
Sensor de seguridad en la tapa
- ✓ **Pulse Button**
Tecla pulsar
- ✓ **Stainless steel bowl**
Olla de inoxidable



Prepares Peanut Butter
Perfecto para hacer crema de mani



See-through lid
Tapa de policarbonato



Scraper Kit included
Kit rascador incorporado



Cooked meat shredder blade (optional)

Cuchilla deshiladora de carnes (opcional)



MODEL / MODELO	CR-4LR	CR-8LR
Voltage / frequency / phases <i>Tensión eléctrica / frecuencia / fases</i>	110V / 60 Hz / 1 220 V / 50 Hz / 1 220 V / 60 Hz / 1	110V / 60 Hz / 1 220 V / 50 Hz / 1 220 V / 60 Hz / 1
Power rating <i>Potencia</i>	0,5 HP	1 HP
Dimensions (H x W x L) <i>Dimensiones (Al x An x L)</i>	530 x 265 x 275 mm	590 x 320 x 335 mm
Package size (H x W x L) <i>Dimensiones del embalaje (Al x An x L)</i>	530 x 320 x 320 mm	600 x 360 x 380 mm
Net / gross weight <i>Peso neto / bruto</i>	15,25 kg / 16,40 kg	19,30 kg / 20,10 kg
Consumption <i>Consumo</i>	0,8 kW-h	1 kW-h
Rotation <i>Rotación</i>	1.750 rpm	1.750 rpm
HS code <i>Partida arancelaria</i>	84659190	84659190



CR-4LR
WEBSITE



CR-8LR
WEBSITE



CR-4LR
SITIO WEB



CR-8LR
SITIO WEB



In Skymssen you can trust.
Si es Skymssen, puedes confiar.

30

www.skymssen.com





PEELERS PELADORAS

PEEL POTATOES, ONIONS OR GARLIC WITH SKYMSSEN'S LINE OF 6 KG ABRASIVE DISC PEELERS.
AHORRA TIEMPO ENTRE COCINA. PELADORA DE PAPAS CON SISTEMA DE DISCO ABRASIVO Y AGUA.



BAR AND
RESTAURANT
BAR Y RESTAURANTE

DA-06 / DC-06 / DB-06

GARLIC PEELER, STAINLESS STEEL, 4 kg / ONION PEELER, STAINLESS STEEL, 6 kg / POTATO PEELER, STAINLESS STEEL, 6 kg
PELADORA DE AJO, INOXIDABLE, 4 kg / PELADORA DE CEBOLLA, INOXIDABLE, 6 kg / PELADORA DE PAPAS, INOXIDABLE, 6 kg



OPTIMIZE TIME IN YOUR KITCHEN!

¡OPTIMIZA EL TIEMPO EN TU COCINA!

- ✓ High durability abrasive disc included
Disco abrasivo de alta durabilidad incluido
- ✓ Easy and practical abrasive disc removal
Retirada del disco abrasivo de forma sencilla y práctica
- ✓ Easy to sanitize
Fácil higienización
- ✓ 4 to 6 kg per cycle capacity
Capacidad de 4 a 6 kg por ciclo
- ✓ Approximate output 70 kg/h (DA-06) and 120 kg/h (DC-06 and DB-06)
*Producción aproximada de 70 kg/h (DA-06)
120 kg/h (DC-06 y DB-06)*



THREE IN ONE TRES EN UNO

Available in 3 versions equipped with one disc, either for garlic, potato or onion. You can also purchase the other discs separately.

Equipo disponible en 3 versiones, cada máquina viene con uno solo disco, o para ajo, papa, o cebolla. Puedes comprar los demás discos por separado.

3 INTERCHANGEABLE DISCS! ¡3 DISCOS INTERCAMBIABLES!



DA6
GARLIC ABRASIVE DISC
DISCO ABRASIVO AJO



DC6
ONION ABRASIVE DISC
DISCO ABRASIVO CEBOLLA



DB6
POTATO ABRASIVE DISC
DISCO ABRASIVO PAPAS

ACCESSORIES SOLD SEPARATELY
ACCESORIOS VENDIDO POR SEPARADO

MODEL / MODELO	DA-06	DC-06	DB-06
Voltage / frequency / phases <i>Tensión eléctrica / frecuencia / fases</i>	110 V / 60 Hz / 1 220 V / 50 Hz / 1 220 V / 60 Hz / 1	110 V / 60 Hz / 1 220 V / 50 Hz / 1 220 V / 60 Hz / 1	110 V / 60 Hz / 1 220 V / 50 Hz / 1 220 V / 60 Hz / 1
Power rating <i>Potencia</i>	0,5 CV	0,5 CV	0,5 CV
Capacity per cycle <i>Capacidad por ciclo</i>	4 kg	6 kg	6 kg
Consumption <i>Consumo</i>	0,37 kW.h	0,37 kW.h	0,37 kW.h
Dimensions (H x W x L) <i>Dimensiones (Al x An x L)</i>	585 x 490 x 390 mm	585 x 490 x 390 mm	630 x 390 x 390 mm
Package size (H x W x L) <i>Dimensiones del embalaje (Al x An x L)</i>	660 x 410 x 410 mm	660 x 410 x 410 mm	660 x 410 x 410 mm
Net / gross weight <i>Peso neto / bruto</i>	20,70 kg / 22,50 kg	19,00 kg / 20,80 kg	18,40 kg / 21,30 kg
Approximate output <i>Producción aproximada</i>	70 kg/h	120 kg/h	120 kg/h
HS code <i>Partida arancelaria</i>	84386000	84386000	84386000



DA-06
WEBSITE



DC-06
WEBSITE



DB-06
WEBSITE



DA-06
SITIO WEB



DC-06
SITIO WEB



DB-06
SITIO WEB



In Skymssen you can trust.
Si es Skymssen, puedes confiar.

31

www.skymssen.com



ILLUSTRATIVE PHOTO. ACTUAL PRODUCTS AND ACCESSORIES MAY CHANGE.
FOTO ILUSTRATIVA. PRODUCTOS REALES Y ACCESORIOS PUEDEN CAMBIAR.



PEELERS PELADORAS

ESPECIALLY DESIGNED TO PEEL GARLIC WITHOUT DAMAGES TO THE CLOVES, WITH A RUNNING WATER SYSTEM AND A SPINNING METALLIC DISC WITH RUBBER BUMPS.

ESPECIALMENTE DISEÑADO PARA PELAR AJOS SIN DAÑARLOS, CON SISTEMA DE AGUA CORRIENTE Y DISCO CON TIRAS DE GOMA.



BAR AND
RESTAURANT
BAR Y RESTAURANTE

DAL-06S

GARLIC PEELER, STAINLESS STEEL, 4 kg
PELADORA DE AJO, INOXIDABLE, 4 kg



OPTIMIZE TIME IN YOUR KITCHEN

¡OPTIMIZA EL TIEMPO EN TU COCINA!

- ✓ Disc with rubber bumps of high durability included
Disco con tiras de goma de alta durabilidad incluido
- ✓ Easy and practical disc removal
Retirada del disco de forma sencilla y práctica
- ✓ Easy to sanitize
Fácil higienización
- ✓ 4 kg per cycle capacity, average production of 70 kg/h
Capacidad de 4 kg por ciclo y producción aproximada de 70 kg/h
- ✓ Ideal for immediate use of garlic or for later making crushed or paste garlic.
Ideal para uso inmediato del ajo o para luego hacer ajo triturado o en pasta.



IMPORTANT ¡IMPORTANTE

Processes garlic cloves only. Do not place entire garlic heads in the peeler.

Procesa solo dientes de ajo. No coloques cabezas de ajo enteras en el pelador.

MODEL / MODELO	DAL-06S
Voltage / frequency / phases <i>Tensión eléctrica / frecuencia / fases</i>	110 V / 60 Hz / 1 220 V / 50 Hz / 1 220 V / 60 Hz / 1
Power rating <i>Potencia</i>	0,5 CV
Capacity per cycle <i>Capacidad por ciclo</i>	4 kg
Consumption <i>Consumo</i>	0,37 kW.h
Dimensions (H x W x L) <i>Dimensiones (Al x An x L)</i>	630 x 390 x 390 mm
Package size (H x W x L) <i>Dimensiones del embalaje (Al x An x L)</i>	660 x 410 x 410 mm
Net / gross weight <i>Peso neto / bruto</i>	18,20 kg / 21,00 kg
Approximate output <i>Producción aproximada</i>	70 kg/h
HS code <i>Partida arancelaria</i>	84386000



DAL-06S
WEBSITE



DAL-06S
SITIO WEB

ILLUSTRATIVE PHOTO. ACTUAL PRODUCTS AND ACCESSORIES MAY CHANGE.
FOTO ILUSTRATIVA. PRODUCTOS REALES Y LOS ACCESORIOS PUEDEN CAMBIAR.



In Skymssen you can trust.
Si es Skymssen, puedes confiar.

32

www.skymssen.com





PEELERS PELADORAS

SAVE TIME IN YOUR KITCHEN! POTATO PEELER WITH RUNNING WATER AND ABRASIVE DISC SYSTEM.
¡AHORRA TIEMPO EN TU COCINA! PELADORA DE PAPAS CON SISTEMA DE DISCO ABRASIVO Y AGUA.



BAR AND
RESTAURANT
BAR Y RESTAURANTE

DB-10

POTATO PEELER, WITH DOOR, STAINLESS STEEL, 10 kg
PELADORA DE PAPAS, CON PUERTA, INOXIDABLE, 10 kg



- ✓ Peel up to 10 kg of potatoes in approximately 2 minutes

Pela hasta 10kg de papas en aproximadamente 2 minutos

- ✓ High durability abrasive disc included

Disco abrasivo de alta durabilidad (incluido)

- ✓ Easy and practical disc removal

Retirada del disco de forma sencilla y práctica

- ✓ Door for a fast and safe removal of peeled products

Puerta para retirada de alimentos de forma segura y rápida

- ✓ Easy to sanitize

Fácil higienización

- ✓ Constructed in stainless steel

Construcción en acero inoxidable



POTATO ABRASIVE DISC
DISCO ABRASIVO PAPAS

MODEL / MODELO	DB-10
Voltage / frequency / phases <i>Tensión eléctrica / frecuencia / fases</i>	110 V / 60 Hz / 1 220 V / 50 Hz / 1 220 V / 60 Hz / 1
Power rating <i>Potencia</i>	0,5 CV
Capacity per cycle <i>Capacidad por ciclo</i>	10 kg
Consumption <i>Consumo</i>	0,37 kW.h
Dimensions (H x W x L) <i>Dimensiones (Al x An x L)</i>	720 x 475 x 580 mm
Package size (H x W x L) <i>Dimensiones del embalaje (Al x An x L)</i>	760 x 530 x 630 mm
Net / gross weight <i>Peso neto / bruto</i>	26,40 kg / 30,20 kg
Approximate output <i>Producción aproximada</i>	200 kg/h
HS code <i>Partida arancelaria</i>	84386000



DB-10
WEBSITE



DB-10
SITIO WEB

ILLUSTRATIVE PHOTO. ACTUAL PRODUCTS AND ACCESSORIES MAY CHANGE.
FOTO ILUSTRATIVA. PRODUCTOS REALES Y LOS ACCESORIOS PUEDEN CAMBIAR.



In Skymssen you can trust.
Si es Skymssen, puedes confiar.

33

www.skymssen.com



BRAZILIAN INDUSTRY
INDUSTRIA BRASILEÑA



PEELERS PELADORAS

ESPECIALLY DESIGNED TO PEEL GARLIC WITHOUT DAMAGES TO THE CLOVES, WITH A RUNNING WATER SYSTEM AND A SPINNING METALLIC DISC WITH RUBBER BUMPS.
ESPECIALMENTE DISEÑADO PARA PELAR AJOS SIN DAÑARLOS, CON SISTEMA DE AGUA CORRIENTE Y DISCO CON TIRAS DE GOMA.



BAR AND
RESTAURANT
BAR Y RESTAURANTE

DB-25HD

GARLIC PEELER, STAINLESS STEEL, 4 kg
PELADORA DE AJO, INOXIDABLE, 4 kg



- ✓ Exit door allows a safe and quick removal of the processed products
Puerta para retirada de alimentos de forma segura y rápida
- ✓ High durability abrasive disc included
Disco abrasivo de alta durabilidad incluido
- ✓ Easy and practical disc removal
Retirada del disco de forma sencilla y práctica
- ✓ Easy to sanitize
Fácil higienización
- ✓ Reinforced structure in stainless steel
Construcción reforzada en acero inoxidable
- ✓ High productivity up to 500 kg/h
Alta productividad de hasta 500 kg/h
- ✓ Timer allows a better production control
Temporizador para un mejor control de la producción

POTATO ABRASIVE DISC (INCLUDED)
DISCO ABRASIVO PAPAS (INCLUIDO)



CC-25HD

PEEL STRAINER BOX -
SEPARATES POTATO PEEL
FROM WATER AND AVOIDS THE
BLOCKING OF WATER EXIT
PIPES

CAJA COLECTORA DE RESÍDUOS - QUE
RECOGE LAS PELADURAS Y EVITA
OBSTRUCCIÓN DEL DESAGUE

ACCESSORIES SOLD SEPARATELY
ACCESORIOS VENDIDO POR SEPARADO

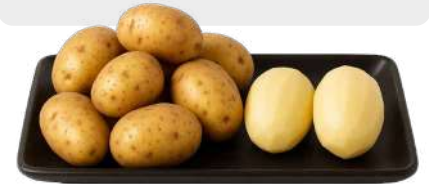

MODEL / MODELO	DB-25HD
Voltage / frequency / phases <i>Tensión eléctrica / frecuencia / fases</i>	110 V / 60 Hz / 1 220 V / 50 Hz / 1 220 V / 60 Hz / 1
Power rating <i>Potencia</i>	1 CV
Capacity per cycle <i>Capacidad por ciclo</i>	25 kg
Consumption <i>Consumo</i>	0,73 kW.h
Dimensions (H x W x L) <i>Dimensiones (Al x An x L)</i>	1.155 x 550 x 670 mm
Package size (H x W x L) <i>Dimensiones del embalaje (Al x An x L)</i>	1.350 x 630 x 750 mm
Net / gross weight <i>Peso neto / bruto</i>	45,00 kg / 82,00 kg
Approximate output <i>Producción aproximada</i>	500 kg/h
HS code <i>Partida arancelaria</i>	84386000



DB-25HD
WEBSITE



DB-25HD
SITE WEB

ILLUSTRATIVE PHOTO. ACTUAL PRODUCTS AND ACCESSORIES MAY CHANGE.
FOTO ILUSTRATIVA. PRODUCTOS REALES Y ACCESORIOS PUEDEN CAMBIAR.



In Skymssen you can trust.
Si es Skymssen, puedes confiar.

34

www.skymssen.com





CITRUS JUICERS EXPRIMIDORES DE CÍTRICOS

EXTRACT FRESH JUICE FROM CITRUS FRUITS SUCH AS ORANGES, LEMONS AND GRAPEFRUIT.
PRODUCTIVIDAD Y CALIDAD PARA JUGOS CÍTRICOS.



BAR AND
RESTAURANT
BAR Y RESTAURANTE

ES / ESL

CITRUS JUICER, STAINLESS STEEL
EXPRIMIDOR DE CÍTRICOS INOXIDABLE



POLYPROPYLENE CHAMBER.
CÁMARA DE POLIPROPILENO.



STAINLESS STEEL CHAMBER.
CÁMARA DE INOXIDABLE.

THE STRENGTH YOU NEED LA FUERZA QUE NECESITAS

A durable and powerful equipment for your business' day-to-day operations.

Un equipo potente y duradero para las operaciones diarias de tu empresa.

- Comes with
 - Large Crown (Oranges)
 - Small Crown (Lemons)
 Acompaña
 - Cono grande (naranjas)
 - Cono pequeño (limones)

- Stainless steel
Gabinete en Acero Inoxidable
- Cup and sieve included
Vaso y colador incluidos



MODEL / MODELO	ES	ESL
Voltage / frequency / phases <i>Tensión eléctrica / frecuencia / fases</i>	110 V / 60 Hz / 1 220 V / 50-60 Hz / 1	110 V / 60 Hz / 1
Power rating <i>Potencia</i>	0,25 HP-CV	0,25 HP-CV
Rotation <i>Rotación</i>	1.750 rpm	1.750 rpm
Consumption <i>Consumo</i>	0.18 kW-h	0.18 kW-h
Dimensions (H x W x L) <i>Dimensiones (Al x An x L)</i>	315 x 305 x 175 mm	315 x 305 x 175 mm
Package size (H x W x L) <i>Dimensiones del embalaje (Al x An x L)</i>	390 x 245 x 245 mm	390 x 245 x 245 mm
Net / gross weight <i>Peso neto / bruto</i>	3,63 kg / 4,15 kg	3,78 kg / 4,30 kg
Fruits per minute (Aprox.) <i>Frutas por minuto (Aprox.)</i>	8	8
HS code <i>Partida arancelaria</i>	84388090	84388090



ES
WEBSITE



ESL
WEBSITE



ES
SITIO WEB



ESL
SITIO WEB

ILLUSTRATIVE PHOTO. ACTUAL PRODUCTS AND ACCESSORIES MAY CHANGE.
FOTO ILUSTRATIVA. PRODUCTOS REALES Y LOS ACCESORIOS PUEDEN CAMBIAR.



In Skymesen you can trust.
Si es Skymesen, puedes confiar.

35

www.skymesen.com



BRAZILIAN INDUSTRY
INDUSTRIA BRASILEÑA



CITRUS JUICERS EXPRIMIDORES DE CÍTRICOS

EXTRACT FRESH JUICE FROM CITRUS FRUITS SUCH AS ORANGES, LEMONS AND GRAPEFRUIT.
PRODUCTIVIDAD Y CALIDAD PARA JUGOS CÍTRICOS.



BAR AND
RESTAURANT
BAR Y RESTAURANTE

EX / EX SUPER

CITRUS JUICER, STAINLESS STEEL, ALUMINUM LIQUID CHAMBER
EXPRIMIDOR DE CÍTRICOS INOXIDABLE, CÁMARA DE JUGOS ALUMINIO



Now with splash
blocker (included)

Protector contra salpicaduras
(incluido)

THE STRENGTH YOU NEED LA FUERZA QUE NECESITAS

A durable and powerful equipment for your business' day-to-day operations.

Un equipo potente y duradero para las operaciones diarias de tu empresa.

- ✓ Comes with
 - Large Crown (Oranges)
 - Small Crown (Lemons)
- Acompaña
- Cono grande (naranjas)
 - Cono pequeño (limones)

- ✓ Stainless steel
Gabinete en Acero Inoxidable
- ✓ Cup and sieve included
Vaso y colador incluidos



MODEL / MODELO	EX	EX SUPER
Voltage / frequency / phases Tensión eléctrica / frecuencia / fases	110 V / 60 Hz / 1 220 V / 50 Hz / 1 220 V / 60 Hz / 1	110 V / 60 Hz / 1 220 V / 50 Hz / 1 220 V / 60 Hz / 1
Power rating Potencia	0,25 HP	0,25 HP
Rotation Rotación	1.750 rpm	1.750 rpm
Consumption Consumo	0.18 kW-h	0.18 kW-h
Dimensions (H x W x L) Dimensiones (Al x An x L)	425 x 245 x 210 mm	425 x 245 x 210 mm
Package size (H x W x L) Dimensiones del embalaje (Al x An x L)	460 x 260 x 260 mm	460 x 260 x 260 mm
Net / gross weight Peso neto / bruto	4,00 kg / 5,00 kg	5,50 kg / 6,00 kg
Fruits per minute (Aprox.) Frutas por minuto (Aprox.)	8	8
HS code Partida arancelaria	84388090	84388090



EX
WEBSITE



EX SUPER
WEBSITE



EX
SITIO WEB



EX SUPER
SITIO WEB

ILLUSTRATIVE PHOTO. ACTUAL PRODUCTS AND ACCESSORIES MAY CHANGE.
FOTO ILUSTRATIVA. PRODUCTOS REALES Y ACCESORIOS PUEDEN CAMBIAR.



In Skymesen you can trust.
Si es Skymesen, puedes confiar.

36

www.skymesen.com



BRAZILIAN INDUSTRY
INDUSTRIA BRASILEÑA



CITRUS JUICERS EXPRIMIDORES DE CÍTRICOS

EXTRACT FRESH JUICE FROM CITRUS FRUITS SUCH AS ORANGES, LEMONS AND GRAPEFRUIT.
PRODUCTIVIDAD Y CALIDAD PARA JUGOS CÍTRICOS.

BAR AND
RESTAURANT
BAR Y RESTAURANTE

ESB-N / ESB SUPER-N

CITRUS JUICER, STAINLESS STEEL, STAINLESS STEEL LIQUID CHAMBER
EXPRIMIDOR DE CÍTRICOS INOXIDABLE, CÁMARA DE JUGOS INOXIDABLE



- ✓ Comes with
 - Large Crown (Oranges)
 - Small Crown (Lemons)

Acompaña

- Cono grande (naranjas)
- Cono pequeño (limones)

- ✓ Cup and sieve included
Vaso y colador incluidos

- ✓ Durable and robust structure
Construcción duradero y robusta

- ✓ Stainless Steel housing and liquids chamber
Cámara de jugos en acero inoxidable



MODEL / MODELO	ESB-N	ESB SUPER-N
Voltage / frequency / phases <i>Tensión eléctrica / frecuencia / fases</i>	110 V / 60 Hz / 1 220 V / 50-60 Hz / 1	110 V / 60 Hz / 1 220 V / 50 Hz / 1 220 V / 60 Hz / 1
Power rating <i>Potencia</i>	0,25 HP	0,5 HP
Rotation <i>Rotación</i>	1.750 rpm 1.500 rpm	1.750 rpm 1.500 rpm 1.750 rpm
Consumption <i>Consumo</i>	0.33kW-h	0.50 kW-h
Dimensions (H x W x L) <i>Dimensiones (Al x An x L)</i>	440 x 360 x 270 mm	440 x 360 x 270 mm
Package size (H x W x L) <i>Dimensiones del embalaje (Al x An x L)</i>	485 x 310 x 315 mm	485 x 310 x 315 mm
Net / gross weight <i>Peso neto / bruto</i>	4,55 kg / 5,80 kg	7,90 kg / 9,10 kg
Fruits per minute (Aprox.) <i>Frutas por minuto (Aprox.)</i>	8	8
HS code <i>Partida arancelaria</i>	84388090	84388090





CITRUS JUICERS EXPRIMIDORES DE CÍTRICOS

EXTRACT FRESH JUICE FROM CITRUS FRUITS SUCH AS ORANGES, LEMONS AND GRAPEFRUIT.
PRODUCTIVIDAD Y CALIDAD PARA JUGOS CÍTRICOS.



BAR AND
RESTAURANT
BAR Y RESTAURANTE

CSE

CITRUS JUICER, STAINLESS STEEL, ALUMINUM LIQUID CHAMBER
EXPRIMIDOR DE CÍTRICOS INOXIDABLE, CÁMARA DE JUGOS ALUMINIO



SEPARATE JUICE FROM SEED WHILE SQUEEZING

SEPARA EL JUGO DE LA SEMILLA
MIENTRAS EXPRIMA

The Cutter has plenty of power to grind meat and chop nuts and various types of vegetables. It also prepares pâtés, purées, spreads, sauces, and a wide variety of recipes.

El Cutter tiene potencia de sobra para picar carne y triturar frutos secos y diversos tipos de verduras. Además, también prepara patés, purés, pastas, salsas y una gran variedad de recetas.

- ✓ Extra wide mouthpiece
Boca de alimentación ancha
- ✓ Robust chamber made of die-cast aluminum
Cámara robusta fabricada en aluminio fundido a presión
- ✓ Cabinet, liquid chamber and sieve made of stainless steel
Gabinete, cámara de líquido y colador en acero inoxidable
- ✓ Waste collector in aluminum
Recolector de residuos en aluminio



NATURAL AND HEALTHY JUICES JUGOS NATURALES Y SALUDABLES

Easily and quickly extracted juice from apples, carrots, beets, cucumbers, pineapples, oranges, kale, ginger and many others.

Perfecto para jugo de manzanas, zanahorias, remolachas, pepinos, apio y muchos otros.



The pulp leftovers can be used in breads, jellies, cakes, and others.

Los residuos de pulpa se pueden utilizar en recetas de panes, jaleas, pasteles y otros.



Nutrient-rich juices from fresh fruits

Jugos de frutas ricos en nutrientes

MODEL / MODELO	CSE
Voltage / frequency / phases Tensión eléctrica / frecuencia / fases	110 V / 60 Hz / 1 220 V / 50 Hz / 1 220 V / 60 Hz / 1
Power rating Potencia	0,5 HP
Rotation Rotación	3.500 rpm
Consumption Consumo	0.18 kW-h
Dimensions (H x W x L) Dimensiones (Al x An x L)	680 x 480 x 280 mm
Package size (H x W x L) Dimensiones del embalaje (Al x An x L)	610 x 460 x 330 mm
Net / gross weight Peso neto / bruto	15,50 kg / 17,00 kg
HS code Partida arancelaria	84388090



CSE
WEBSITE



CSE
SITIO WEB

ILLUSTRATIVE PHOTO. ACTUAL PRODUCTS AND ACCESSORIES MAY CHANGE.
FOTO ILUSTRATIVA. PRODUCTOS REALES Y ACCESORIOS PUEDEN CAMBIAR.



In Skymesen you can trust.
Si es Skymesen, puedes confiar.

38

www.skymesen.com



BRAZILIAN INDUSTRY
INDUSTRIA BRASILEIRA



FRUIT PULPER MACHINES DESPULPADORAS DE FRUTAS

IDEAL FOR HIGH PRODUCTION, IT ENSURES OPTIMIZED PERFORMANCE THAT MAKES DAILY OPERATION EASIER WITH SPEED AND PRECISION.
IDEAL PARA ALTA PRODUCCIÓN, GARANTIZA UN RENDIMIENTO OPTIMIZADO QUE FACILITA LA OPERACIÓN DIARIA CON AGILIDAD Y PRECISIÓN.



BAR AND
RESTAURANT
BAR Y RESTAURANTE

DF10 / DF20

FRUIT AND AÇAÍ PULPER, 10 LITERS / FRUIT AND AÇAÍ PULPER, 20 LITERS
DESPULPADORA DE FRUTAS Y AÇAÍ, 10 LITROS / DESPULPADORA DE FRUTAS Y AÇAÍ, 20 LITROS



PROCESSING VERSATILITY VERSATILIDAD DE PROCESAMIENTO

Capable of processing a variety of fruits, such as açai, mango, and passion fruit, expanding the range of final products. Leaves the pulp smooth with an ideal texture, ensuring a high-quality final product.

Capaz de procesar varias frutas, como açai, mango y maracuyá, ampliando la gama de productos finales. Deja la pulpa homogénea con la textura ideal, garantizando un producto final de alta calidad.

- ✓ Easy to clean
Fácil de limpiar
- ✓ Efficient Extraction System
Sistema de Extracción Eficiente
- ✓ Mechanical Safety
Seguridad Mecánica
- ✓ Electrical Safety
Seguridad Eléctrica
- ✓ Stainless steel bowl, beaters, and sieve
Tazón, batidores y coladores de acero inoxidable
- ✓ Interchangeable strainers
Coladores intercambiables



STRAINERS INCLUDED COLADORES INCLUIDOS

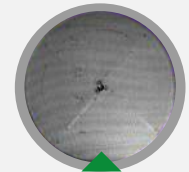

Strainer with Ø0.8 mm hole
Colador con orificio de Ø0,8 mm

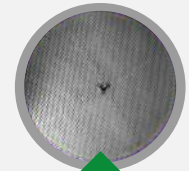

Strainer with Ø1,5 mm hole
Colador con orificio de Ø1,5 mm

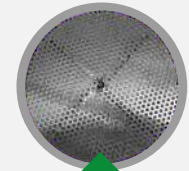

Strainer with Ø5 mm hole
Colador con orificio de Ø5 mm

MODEL / MODELO	DF10	DF20
Voltage / frequency / phases Tensión eléctrica / frecuencia / fases	127/220 V / 60 Hz / 1	127/220 V / 60 Hz / 1
Rated power Potencia nominal	600 W	600 W
Motor power Potencia del motor	0,5 HP-CV	0,5 HP-CV
Dimensions (H x W x L) Dimensiones (Al x An x L)	1022 x 375 x 660 mm	1022 x 415 x 700 mm
Package size (H x W x L) Dimensiones del embalaje (Al x An x L)	1.185 x 495 x 825 mm	1.185 x 495 x 825 mm
Net / gross weight Peso neto / bruto	27,5 kg / 33,5 kg	29 kg / 37 kg
Bowl size Tamaño del recipiente	Ø 177mm	Ø 253mm
Consumption Consumo	0,6 kw/h	0,6 kw/h
HS code Partida arancelaria	84386000	84386000



DF10
WEBSITE



DF20
WEBSITE



DF10
SITIO WEB



DF20
SITIO WEB

ILLUSTRATIVE PHOTO. ACTUAL PRODUCTS AND ACCESSORIES MAY CHANGE.
FOTO ILUSTRATIVA. PRODUCTOS REALES Y ACCESORIOS PUEDEN CAMBIAR.



In Skymssen you can trust.
Si es Skymssen, puedes confiar.

39

www.skymssen.com



BRAZILIAN INDUSTRY
INDUSTRIA BRASILEIRA

FIND OUT WHICH FRYER IS IDEAL FOR YOUR BUSINESS.

DESCUBRA CUÁL ES LA FREIDORA PERFECTA PARA SU NEGOCIO.



BASED ON THE FRYING SYSTEMS, SKYMSSEN HAS DEVELOPED THE FOLLOWING PRODUCT LINES: REGULAR OIL FRYERS, COLD ZONE FRYERS AND WATER AND OIL FRYERS.

BASADA EN LOS SISTEMAS DE FRITURA, SKYMSSEN HA DESARROLLADO LAS SIGUIENTES LÍNEAS DE PRODUCTOS: FREIDORAS SOLO ACEITE, FREIDORAS SOLO ACEITE EN ZONA FRÍA Y FREIDORAS AGUA Y ACEITE.

#01

REGULAR OIL FRYER FREIDORA SOLO ACEITE

Your heat source is always at the bottom of the tank, heating the oil completely. Therefore, they have smaller tanks of 5 liters and are recommended for small portions.

Su fuente de calor siempre está en el fondo del tanque, calentando el aceite por completo, por eso tienen cubas más pequeños de 5 litros y son recomendadas para pequeñas porciones.

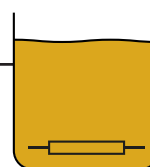

OIL
ACEITE

MODELS
MODELOS

FE-10-N
FED-20-N

#02

COLD ZONE FRYERS FREIDORAS SOLO ACEITE EN ZONA FRÍA

They have a low-temperature area at the bottom of the tank for residue decantation because the heat source is positioned well above the tank's bottom, heating only the upper part of the oil. This prevents the oil from burning, reducing the formation of harmful substances and increasing its lifespan. They have larger tanks ranging from 15 to 20 liters and are recommended for high production, as in fast food restaurants and burger joints.

Tienen un área de baja temperatura en la parte inferior del tanque para la decantación de residuos, ya que la fuente de calor está posicionada bien por encima del fondo del tanque, calentando solo la parte superior del aceite. Esto evita que el aceite se queme, reduciendo la formación de sustancias perjudiciales para la salud y aumentando la vida útil del aceite. Tienen cuba mayor de entre 15 a 20 litros y son recomendadas para producciones mayores, comúnmente estandarizadas como en los restaurantes de comida rápida y hamburguerías.

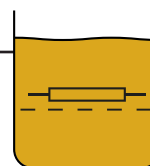

COLD ZONE
ZONA FRÍA

MODELS
MODELOS

F2M
F2M8
F2P
F2P8
FE28S
FG20 GLP
FG20 GN
FG25S GLP
FG25S GN

#03

WATER AND OIL FRYERS FREIDORAS AGUA Y ACEITE

It is similar to a cold zone fryer, but with a brine solution (water and coarse salt) added to the bottom of the tank. The oil stays on top and only it is heated. This way, frying residues settle in the brine, preventing burning, minimizing flavor transfer, and extending the oil's lifespan. Recommended for high-volume production of various types of food.

Es similar a una freidora de zona fría, pero con una solución de salmuera (agua y sal gruesa) añadida en la parte inferior del tanque. El aceite queda en la parte superior y solo él se calienta. De esta forma, los residuos de la fritura se depositan en la salmuera, evitando que se quemen, minimizando la transferencia de sabores y haciendo que el aceite dure más tiempo. Indicadas para una alta producción de diversos tipos de alimentos.

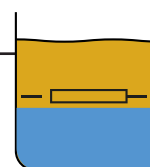

WATER
AND OIL
AGUA Y ACEITE

MODELS
MODELOS

FE25
FE38



ELECTRIC FRYERS OIL FREIDORAS ELÉCTRICAS ACEITE

PREPARES SAVOURING AND CRUSTY DEEP FRIED INGREDIENTS.
PERFECTAS PARA PAPAS FRITAS, EMPANADAS, PORCIONES VÁRIAS.

BAR AND
RESTAURANT
BAR Y RESTAURANTE

FE-10-N / FED-20-N

ELECTRIC FRYER, 5 LITERS, STAINLESS STEEL / ELECTRIC FRYER, TWO TANKS, 5 LITERS EACH, STAINLES STEEL
FREIDORA ELECTRICA, 5 LITROS, INOXIDABLE FREIDORA ELECTRICA, 2 CUBAS DE 5 LITROS, INOXIDABLE



FRIED AND CRISPY INGREDIENTS

PAPAS FRITAS Y CRUJIENTES

With low oil volume, it delivers excellent results and lower energy consumption. It is perfect for kitchens, bars, cafeterias and food trucks.

Con tan solo 5L aceite ofrece excelentes resultados y menor consumo de energía. Es perfecto para cocinas, bares, cafeterías y food trucks.



QUICKLY RESTORES TEMPERATURE
RESTABLECE RÁPIDAMENTE LA TEMPERATURA

BASKET WITH COATED GRIP
CANASTA CON MANGO REVESTIDO

✓ Compact and portable
Compacta y portátil

✓ With lid
Con tapa

✓ Waste protective grid
Rejilla protectora de residuos

✓ Temperature control by thermostat and safety thermostat
Control de temperatura por termostato

✓ Tank and panel with removable heating elements for cleaning
Cuba y panel extraíbles para limpieza

✓ Lamp to indicate that the heating element is on
LED indicador resistencia eléctrica prendida

✓ Stainless steel shielded heating element
Resistencia blindada de acero inoxidable

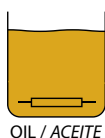

OIL / ACEITE

MODEL / MODELO	FE-10-N	FED-20-N
Voltage / frequency / phases Tensión eléctrica / frecuencia / fases	110 V / 50-60 Hz / 1 220 V / 50-60 Hz / 1	110 V / 50-60 Hz / 1 220 V / 50-60 Hz / 1
Power rating Potencia	2.000 W 3.300 W	2.000 W (2x) 3.300 W (2x)
Dimensions (H x W x L) Dimensiones (Al x An x L)	280 x 300 x 670 mm	280 x 610 x 670 mm
Package size (H x W x L) Dimensiones del embalaje (Al x An x L)	320 x 315 x 485 mm	320 x 595 x 485 mm
Net / gross weight Peso neto / bruto	4,00 kg / 5,70 kg	7,80 kg / 10,40 kg
Tank capacity Capacidad del tanque	5 L	5 L (2x)
Basket dimensions (HxWxL) Dimensiones del canasto (Al x An x L)	105 x 190 x 220 mm	105 x 190 x 220 mm (2x)
Basket max. load Carga máxima del canasto	0,6 kg	0,6 kg (2x)
Frying area (WxL) Área de fritura (An x L)	240 x 300 mm	240 x 300 mm (2x)
HS code Partida arancelaria	84198190	84198190



FE-10-N
WEBSITE



FED-20-N
WEBSITE



FE-10-N
SITIO WEB



FED-20-N
SITIO WEB



COLD ZONE FRYERS FREIDORAS ELÉCTRICAS ZONA FRÍA

MIDDLE RANGE FRYERS, IN VARIOUS OPTIONS OF SHAPE, POWER AND FRYING SYSTEMS. IDEAL FOR RESTAURANTS, SNACK BARS, FASTFOODS AND HAMBURGER PLACES.
LOS RESÍDUOS QUEDAN ABAJO DE LA RESISTENCIA - ZONA FRÍA - EVITANDO LA QUEMA DE ESTOS RESÍDUOS, AUMENTANDO LA VIDA ÚTIL DEL ACEITE, OPTIMIZANDO LA RENTABILIDAD DE SU NEGOCIO.



BAR AND
RESTAURANT
BAR Y RESTAURANTE

FZM / FZM8 / FZP / FZP8

ELECTRIC FRYER COLD ZONE, 15 LITERS, STAINLESS STEEL, TABLE TOP / ELECTRIC FRYERS, COLD ZONE, 15 LITERS, STAINLESS STEEL, FLOOR STANDING.
FREIDORA ELÉCTRICA ZONA FRÍA, 15 LITROS, INOXIDABLE, DE MESA / FREIDORA ELÉCTRICA ZONA FRÍA, 15 LITROS, INOXIDABLE, DE PISO



HIGH PRODUCTION IN SMALL SPACES

ALTA PRODUCCION X
ESPACIO REDUCIDO

The modular shape of our fryers allows you to create a frying cell, in your kitchen, that will occupy a small space and put out high productivity.

Diseño compacto y modular
y opción de modelo con
recuperación rápida.

- ✓ Compact design
Diseño compacto
- ✓ Safety thermostat
Termostato de seguridad
- ✓ 15 liters oil tank
Cuba para 15 litros de aceite
- ✓ Level marker
Marcador de nivel máximo



5.000 W
1 Temperature thermostat
1 Termostato de temperatura



8.000 W
2 Temperature thermostat
2 Termostato de temperatura



Oil exit tap
*Deságue del aceite
y residuos*



Basket with
coated handle
Canasta con mango

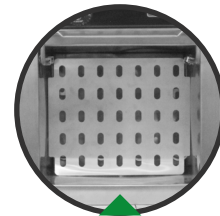

Removable
residues grid
Rejilla de residuos

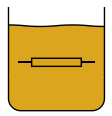

COLD ZONE
ZONA FRÍA



5.000 W
1 Temperature thermostat
1 Termostato de temperatura



8.000 W
2 Temperature thermostat
2 Termostato de temperatura

MODEL / MODELO	FZM	FZM8	FZP	FZP8
Voltage / frequency / phases <i>Tensión eléctrica / frecuencia / fases</i>	220 V / 50-60 Hz / 1	220 V / 50-60 Hz / 1	220 V / 50-60 Hz / 1	220 V / 50-60 Hz / 1
Power rating <i>Potencia</i>	5.000 W	8.000 W	5.000 W	8.000 W
Dimensions (H x W x L) <i>Dimensiones (Al x An x L)</i>	485 x 400 x 590 mm	485 x 400 x 590 mm	970 x 400 x 590 mm	970 x 400 x 590 mm
Package size (H x W x L) <i>Dimensiones del embalaje (Al x An x L)</i>	525 x 450 x 590 mm	525 x 450 x 590 mm	1.030 x 430 x 540 mm	1.030 x 430 x 540 mm
Net / gross weight <i>Peso neto / bruto</i>	11,30 kg / 13,30 kg	12,80 kg / 14,80 kg	14,50 kg / 17,20 kg	15,80 kg / 19,30 kg
Tank capacity <i>Capacidad del tanque</i>	15 L	15 L	15 L	15 L
Basket dimensions (HxWxL) <i>Dimensiones del canasto (Al x An x L)</i>	93 x 117 x 240 mm	93 x 117 x 240 mm	93 x 117 x 240 mm	93 x 117 x 240 mm
Basket max. load <i>Carga máxima del canasto</i>	2 kg	2 kg	2 kg	2 kg
Frying area (WxL) <i>Área de fritura (An x L)</i>	310 x 270 mm	310 x 270 mm	310 x 270 mm	310 x 270 mm
HS code <i>Partida arancelaria</i>	84198190	84198190	84198190	84198190



FZM
WEBSITE



FZM8
WEBSITE



FZP
WEBSITE



FZP8
WEBSITE



FZM
SITIO WEB



FZM8
SITIO WEB



FZP
SITIO WEB



FZP8
SITIO WEB

ILLUSTRATIVE PHOTO. ACTUAL PRODUCTS AND ACCESSORIES MAY CHANGE.
FOTO ILUSTRATIVA. PRODUCTOS REALES Y LOS ACCESORIOS PUEDEN CAMBIAR.



In Skymssen you can trust.
Si es Skymssen, puedes confiar.



ELECTRIC Fryer Split Cold Zone FREIDORA ELÉCTRICA CUBA DIVIDIDA ZONA FRÍA

DEEP FRYING WITH A COLD OIL ZONE FOR HIGHER EFFICIENCY AND LONGER OIL DURABILITY.
FRITURA POR INMERSIÓN CON ZONA FRÍA DE ACEITE PARA MAYOR EFICIENCIA Y DURABILIDAD DEL ACEITE.



BAR AND RESTAURANT
BAR Y RESTAURANTE

FE28S

ELECTRIC Fryer Split Cold Zone 2x14 LITERS, STAINLESS STEEL, THREE-PHASE
FREIDORA ELÉCTRICA ZONA FRÍA CON TANQUES INDEPENDIENTES DE 2x14 LITROS CADA UNO, INOXIDABLE, TRIFÁSICA



THE ONLY ONE THAT DOESN'T MIX FLAVORS

LA ÚNICA QUE NO MEZCLA SABORES

With two independent 14-liter tanks, allowing food separation and preventing flavor mixing. Ideal for establishments with high frying demand.

Con dos tanques independientes de 14 litros, permitiendo la separación de alimentos y evitando la mezcla de sabores. Ideal para establecimientos con alta demanda de frituras.

✓ Digital controller with temperature display and audible alert
Controlador digital con visor de temperatura y aviso sonoro

✓ Robust nickel-plated baskets with coated handle
Canastos niquelados robustos con mango revestido

✓ Cold Zone System
Sistema Zona Fría

✓ 14 L Tanks (2x)
Tanques de 14 L (2x)

✓ Robust Design
Diseño Robusto

✓ Stainless Steel Drainage Tubes
Tubos de Drenaje en Acero Inoxidable

✓ Front Opening Door
Puerta con Apertura Frontal

✓ Oil Level Marking
Marcaje de Nivel de Aceite

✓ 2 Independent Tanks
2 Tanques Independientes

✓ Tilting Heater
Resistencia Basculante

✓ 1.1/4" Drainage Valves
Registros de Drenaje de 1.1/4"



2 Tanks of 14 L
2 TANQUES DE 14 L

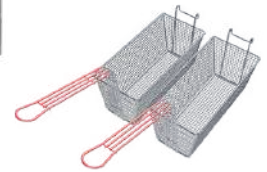

2 Baskets of 1 kg
2 CANASTOS DE 1 KG



Tilting Heater
Resistencia Basculante



Drainage System with Wide Valve
Sistema de Drenaje con Registro Ancho

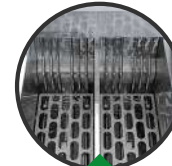

Waste Grates
Rejillas de Residuos

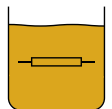

COLD ZONE
ZONA FRÍA

MODEL / MODELO	FE28S
Voltage / frequency / phases Tensión eléctrica / frecuencia / fases	110 V / 50-60 Hz / 3 380 V / 50-60 Hz / 1
Power rating Potencia	16.000 W (2x 8.000 W)
Dimensions (H x W x L) Dimensiones (Al x An x L)	1.055 x 400 x 850 mm
Package size (H x W x L) Dimensiones del embalaje (Al x An x L)	1.240 x 525 x 1.000 mm
Net / gross weight Peso neto / bruto	40 kg / 56 kg
Tank capacity Capacidad del tanque	14 L (2x)
Basket dimensions (HxWxL) Dimensiones del canasto (Al x An x L)	140 x 160 x 335 mm
Basket max. load Carga máxima del canasto	1 kg (2x)
Frying area (WxL) Área de Fritura (An x L)	354 x 365 mm
HS code Partida arancelaria	84198190



FE28S
WEBSITE



FE28S
SITIO WEB

ILLUSTRATIVE PHOTO. ACTUAL PRODUCTS AND ACCESSORIES MAY CHANGE.
FOTO ILUSTRATIVA. PRODUCTOS REALES Y LOS ACCESORIOS PUEDEN CAMBIAR.



In Skymssen you can trust.
Si es Skymssen, puedes confiar.



ELECTRIC FRYERS WATER AND OIL FREIDORAS ELÉCTRICAS AGUA Y ACEITE

POWER TO FRY LARGE VOLUMES OF FOOD, KEEPING THE PRODUCTS ALWAYS DRY AND CRISPY, WITH ECONOMY AND SAFETY.
POTENCIA DE SOBRA PARA FREÍR GRANDES VOLUMENES DE ALIMENTOS, MANTENIENDO LAS FRITURAS SIEMPRE SECAS Y CRUJIENTES,
CON ECONOMÍA Y SEGURIDAD.



BAR AND
RESTAURANT
BAR Y RESTAURANTE

FE25/ FE38

ELECTRIC FRYER WATER AND OIL, 25 / 38 LITERS, STAINLESS STEEL, THREE-PHASE.
FREIDORA ELÉCTRICA AGUA Y ACEITE, 25 / 38 LITROS, ACERO INOXIDABLE, TRIFÁSICA



FOR THOSE WHO UNDERSTAND FRYING PARA QUIENES ENTIENDEN DE FRITURA

High power to fry food in less time, speeding up preparations and serving customers faster.

Alta potencia para freír los alimentos en menos tiempo, agilizando preparaciones y atendiendo a los clientes más rápido.

- ✓ Three-phase electrical design
Proyecto eléctrico trifásico
- ✓ Sturdy nickel-plated baskets with coated handle
Cestos niquelados robustos con mango revestido
- ✓ Front-opening door
Puerta de apertura frontal
- ✓ Equipped with a safety thermostat
Posee termostato de seguridad
- ✓ Digital temperature controller
Controlador de temperatura digital
- ✓ Oil and Water Level Marking
Marcaje de Nivel de Aceite y Agua



FRIES 30KG OF FROZEN POTATOES PER HOUR

15,000 W - 25L of Oil
FRÍE 30KG DE PAPAS CONGELADAS POR HORA

15,000 W - 25L DE ACEITE



Drainage Tube
Tubo de Drenaje

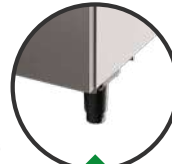

Non-Slip Feet
Patas Antideslizantes

FRIES 45KG OF FROZEN POTATOES PER HOUR

18,000 W - 38L of Oil
FRÍE 45KG DE PAPAS CONGELADAS POR HORA

18,000 W - 38L DE ACEITE

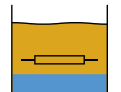

WATER AND OIL
AGUA Y ACEITE

MODEL / MODELO	FE25	FE38
Voltage / frequency / phases <i>Tensión eléctrica / frecuencia / fases</i>	220 V / 50-60 Hz / 3 380 V / 50-60 Hz / 3	220 V / 50-60 Hz / 3 380 V / 50-60 Hz / 3
Power rating <i>Potencia</i>	15.000 W	18.000 W
Dimensions (H x W x L) <i>Dimensiones (Al x An x L)</i>	1.055 x 400 x 850 mm	1.055 x 575 x 850 mm
Package size (H x W x L) <i>Dimensiones del embalaje (Al x An x L)</i>	1.240 x 525 x 1.000 mm	1.240 x 700 x 1.000 mm
Net / gross weight <i>Peso neto / bruto</i>	36 kg / 52 kg	46 kg / 74 kg
Tank capacity <i>Capacidad del tanque</i>	25 L / 5 L / 0.5 kg	38 L / 6 L / 0.5 kg
Basket dimensions (HxWxL) <i>Dimensiones del canasto (Al x An x L)</i>	140 x 160 x 335 mm	140 x 160 x 335 mm
Basket max. load <i>Carga máxima del canasto</i>	1 Kg	1 Kg
Frying area (WxL) <i>Área de Fritura (An x L)</i>	354 x 365 mm	527 x 380 mm
HS code <i>Partida arancelaria</i>	84198190	84198190



FE25
WEBSITE



FE38
WEBSITE



FE25
SITIO WEB



FE38
SITIO WEB

ILLUSTRATIVE PHOTO. ACTUAL PRODUCTS AND ACCESSORIES MAY CHANGE.
FOTO ILUSTRATIVA. PRODUCTOS REALES Y LOS ACCESORIOS PUEDEN CAMBIAR.



In Skymssen you can trust.
Si es Skymssen, puedes confiar.

44

www.skymssen.com



BRAZILIAN INDUSTRY
INDUSTRIA BRASILEIRA



COLD ZONE GAS FRYERS FREIDORAS A GAS DE ZONA FRÍA

PLENTY OF POWER TO FRY LARGE VOLUMES OF FOOD, KEEPING FRIED ITEMS CRISPY AND DRY, WITH EFFICIENCY AND SAFETY.
POTENCIA DE SOBRA PARA FREÍR GRANDES VOLUMENES DE ALIMENTOS, MANTENIENDO LAS FRITURAS SIEMPRE CRUJIENTES Y SECAS, CON AHORRO Y SEGURIDAD



BAR AND
RESTAURANT
BAR Y RESTAURANTE

FG20 GLP / FG20 GN

COLD ZONE GAS FRYER, 20 LITERS, STAINLESS STEEL, MILLIVOLT, GLP / GN
FREIDORA A GAS DE ZONA FRÍA, 20 LITROS, INOX, MILLIVOLT, GLP / GN



FOR THOSE WHO WANT REAL FRYING POWER PARA QUIENES ENTIENDEN DE FRITURA

With impeccable frying capacity, the FG20 fryers deliver consistent results and help you achieve the perfect texture - crispy on the outside, soft on the inside.

Con una capacidad de fritura impecable, las freidoras FG20 garantizan resultados consistentes y permiten lograr la textura perfecta: crujiente por fuera y suave por dentro.

- ✓ Full stainless steel construction
Construcción completamente en acero inoxidable
- ✓ 20 L oil tank
Depósito de aceite de 20 L
- ✓ Power: 90,000 BTU/h
Potencia: 90.000 BTU/h
- ✓ Automatic temperature control
Control automático de temperatura
- ✓ Safety thermostat
Termostato de seguridad
- ✓ Safety system that shuts off the gas in case of flame failure
Sistema de seguridad que corta el gas en caso de ausencia de llama
- ✓ 3 cast iron burners
3 quemadores de hierro fundido
- ✓ Oil level indicator
Marcador de nivel de aceite
- ✓ Ideal for use at a maximum altitude of 1,000 m
Ideal para el uso en altitud máxima de 1.000 m



FG20 GLP / FG20 GN MILLIVOLT VALVE VÁLVULA DE MILLIVOLTIOS

Analog thermostat up to 200°C
Termostato analógico hasta 200°C

Ignition with pilot flame
Encendido con llama piloto

No need for electrical connection
No requiere conexión a la red eléctrica

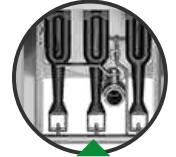

Cast iron Burners
Quemadores de hierro fundido



Non-slip feet with height adjustment
Pies antideslizantes con ajuste de altura



Nickel-plated baskets with coated handle
Cestas niqueladas con mango revestido



COLD ZONE
ZONA FRÍA

MODEL / MODELO	FG20 GLP	FG20 GN
Gas type Tipo de gas	GLP	GN
Power rating Potencia	90.000 BTU/h	90.000 BTU/h
Dimensions (H x W x L) Dimensiones (Al x An x L)	1055 x 405 x 820 mm	1055 x 405 x 820 mm
Package size (H x W x L) Dimensiones del embalaje (Al x An x L)	1240 x 525 x 920 mm	1240 x 525 x 920 mm
Net / gross weight Peso neto / bruto	41,00 kg / 56,00 kg	41,00 kg / 56,00 kg
Tank capacity Capacidad del tanque	20 L	20 L
Basket dimensions (HxWxL) Dimensiones del canasto (Al x An x L)	140 x 160 x 335 mm	140 x 160 x 335 mm
Basket max. load Carga máxima del canasto	1 kg (2x)	1 kg (2x)
Frying area (WxL) Área de fritura (An x L)	354 x 354 mm	354 x 354 mm
HS code Partida arancelaria	84198190	84198190



FG20 GLP
WEBSITE



FG20 GN
WEBSITE



FG20 GLP
SITIO WEB



FG20 GN
SITIO WEB

ILLUSTRATIVE PHOTO. ACTUAL PRODUCTS AND ACCESSORIES MAY CHANGE.
FOTO ILUSTRATIVA. PRODUCTOS REALES Y ACCESORIOS PUEDEN CAMBIAR.



In Skymssen you can trust.
Si es Skymssen, puedes confiar.

45

www.skymssen.com



BRAZILIAN INDUSTRY
INDUSTRIA BRASILEIRA



COLD ZONE GAS FRYERS FREIDORAS A GAS DE ZONA FRÍA

PLENTY OF POWER TO FRY LARGE VOLUMES OF FOOD, KEEPING FRIED ITEMS CRISPY AND DRY, WITH EFFICIENCY AND SAFETY.
POTENCIA DE SOBRA PARA FREÍR GRANDES VOLÚMENES DE ALIMENTOS, MANTENIENDO LAS FRITURAS SIEMPRE CRUJIENTES Y SECAS,
CON AHORRO Y SEGURIDAD.



BAR AND
RESTAURANT
BAR Y RESTAURANTE

FG25S GLP / FG25S GN

GAS FRYER COLD ZONE SPLIT 2x12,5 LITERS, STAINLESS STEEL, MILLIVOLT, LPG
FREIDORA GAS ZONA FRÍA CUBA DIVIDIDA 2x12,5 LITROS, INOXIDABLE, MILIVOLTIO, GLP



THE ONLY ONE THAT DOESN'T MIX FLAVORS

LA ÚNICA QUE NO MEZCLA SABORES

With two independent 12.5-liter tanks, allowing food separation and preventing flavor mixing. Ideal for establishments with high frying demand.

Con dos tanques independientes de 12,5 litros, que permiten separar los alimentos y evitan la mezcla de sabores. Ideal para establecimientos con alta demanda de frituras.

- ✓ Full stainless steel construction
Full stainless steel construction
- ✓ 2 independent tanks
2 tanques independientes
- ✓ Automatic temperature control
Control automático de temperatura
- ✓ Automatic temperature control
Control automático de temperatura
- ✓ Safety thermostat
Termostato de seguridad
- ✓ Safety system that shuts off the gas in case of flame failure
Sistema de seguridad que corta el gas en caso de ausencia de llama



FG20 GLP / FG20 GN MILLIVOLT VALVE VÁLVULA DE MILIVOLTIOS

Analog thermostat up to 200°C
Termostato analógico hasta 200°C

Ignition with pilot flame
Encendido con llama piloto

No need for electrical connection
No requiere conexión a la red eléctrica

2 x 12.5L TANKS
2 TANQUES DE 12,5 L

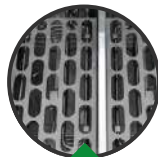

Waste filters
Rejillas de residuos



Nickel-plated baskets
with coated handle
Cestas niqueladas con mango
revestido



Non-slip feet with height
adjustment
Pies antideslizantes con ajuste
de altura

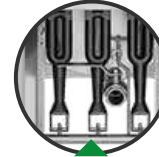

Cast iron Burners
Quemadores de hierro
fundido



MODEL / MODELO	FG20 GLP	FG20 GN
Gas type Tipo de gas	GLP	GN
Power rating Potencia	120.000 BTU/h	120.000 BTU/h
Dimensions (H x W x L) Dimensiones (Al x An x L)	1055 x 405 x 820 mm	1055 x 405 x 820 mm
Package size (H x W x L) Dimensiones del embalaje (Al x An x L)	1240 x 525 x 920 mm	1240 x 525 x 920 mm
Net / gross weight Peso neto / bruto	47,00 kg / 62,00 kg	47,00 kg / 62,00 kg
Tank capacity Capacidad del tanque	12,5 L (Per tank - Por tanque)	12,5 L (Per tank - Por tanque)
Basket dimensions (HxWxL) Dimensiones del canasto (Al x An x L)	140 x 160 x 325 mm	140 x 160 x 335 mm
Basket max. load Carga máxima del canasto	1 kg (2x)	1 kg (2x)
Frying area (WxL) Área de fritura (An x L)	352 x 170 mm	352 x 170 mm
HS code Partida arancelaria	84198190	84198190



FE25
WEBSITE



FE38
WEBSITE



FE25
SITIO WEB



FE38
SITIO WEB

ILLUSTRATIVE PHOTO. ACTUAL PRODUCTS AND ACCESSORIES MAY CHANGE.
FOTO ILUSTRATIVA. PRODUCTOS REALES Y ACCESORIOS PUEDEN CAMBIAR.



In Skymssen you can trust.
Si es Skymssen, puedes confiar.

46

www.skymssen.com



BRAZILIAN INDUSTRY
INDUSTRIA BRASILEIRA



HIGH SPEED BLENDERS 1,5 LITERS LICUADORA DE ALTA VELOCIDAD DE 1,5 LITROS

PREPARE JUICES, DRINKS AND SHAKES
PREPARE JUGOS, BEBIDAS Y BATIDOS, TRITURANDO Y LICUANDO RÁPIDAMENTE LAS PULPAS CONGELADAS Y FRUTA NATURAL.

BAR AND
RESTAURANT
BAR Y RESTAURANTE

LI 1.5

HIGH SPEED BLENDER, STAINLESS STEEL, STAINLESS STEEL CUP, 1.5 LITERS
LICUADORA DE ALTA VELOCIDAD, INOXIDABLE, VASO EN ACERO INOXIDABLE, 1,5 LITROS



BUILT TO LAST CONSTRUIDO PARA DURAR

The LI 1.5 High-Speed Blender is specifically designed for the demanding environments of busy restaurants and bars that require truly durable equipment. Built to last, this powerhouse features a robust 1.5-liter stainless steel cup, ensuring exceptional longevity and resistance to heavy daily use. Its 900 W power rating delivers high-speed performance, perfect for a wide range of culinary tasks.

La Licuadora LI 1.5 de Alta Velocidad está diseñada específicamente para los exigentes entornos de restaurantes y bares concurridos que requieren un equipamiento verdaderamente resistente. Construida para durar, esta potente licuadora cuenta con un robusto vaso de acero inoxidable de 1.5 litros, lo que garantiza una longevidad excepcional y resistencia al uso diario intensivo. Sus 900 W de potencia brindan un rendimiento de alta velocidad, perfecto para una amplia gama de tareas culinarias.



- ✓ Stainless steel cup
Vaso en acero inoxidable
- ✓ Shaft and bushing in stainless steel
Eje y Cojinete en acero inoxidable
- ✓ 900 W power rating
900 W de potencia
- ✓ Removable complete cutting unit easy cleaning
Centro completo del vaso es removible facilitando la limpieza.



MODEL / MODELO	LI 1.5
Voltage / frequency / phases Tensión eléctrica / frecuencia / fases	110 V / 60 Hz / 1 220 V / 50-60 Hz / 1
Power rating Potencia	900 W
Rotation Rotación	18.000 rpm
Dimensions (H x W x L) Dimensiones (Al x An x L)	405 x 210 x 190 mm
Package size (H x W x L) Dimensiones del embalaje (Al x An x L)	445 x 195 x 195 mm
Net / gross weight Peso neto / bruto	1,92 kg / 2,3 kg
Max. cup volume Volumen máximo de vaso	1,5 L
HS code Partida arancelaria	84386000





HIGH SPEED BLENDER 1,5 LITERS WITH SOUND ENCLOSURE LICUADORAS DE ALTAVELOCIDAD DE 1,5 LITROS CON CAJA REDUCTORA DE RUIDOS

IDEAL TO PREPARE JUICES, FROZEN, SMOOTHIES, FRAPPÉS, MILKSHAKES, ICE CREAMS, AÇAÍ CREAM AND LACTOSE-FREE MILK.
IDEAL PARA JUGOS, GRANIZADOS, HIELO, FRAPPÉS, MILKSHAKES, HELADOS, PASTA DE AÇAÍ Y LECHE SIN LACTOSA.



BAR AND
RESTAURANT
BAR Y RESTAURANTE

BAR1.5

BLENDER WITH SOUND ENCLOSURE, TRITAN CUP, WITH VARIABLE SPEED, WITH PREPROGRAMMED FUNCTIONS, 1,5 LITERS
Blender con caja reductora de ruidos, vaso tritan, con variador de velocidad, con funciones pre programadas, 1,5 litros



POWERFUL AND QUIET ROBUSTO Y SILENCIOSO

High performance motor and blades for faster and more efficient preparation. Less noise and more productivity for your business.

Motor y cuchilla de alto rendimiento para preparaciones más rápidas y eficientes. Menos ruido y más productividad para tu negocio.

- ✓ 3 SPEEDS
3 velocidades
- ✓ 3 PRE-PROGRAMMED FUNCTIONS
3 funciones pre programada
- ✓ PULSE BOTTON
Botón de pulse
- ✓ 1,5 LITERS CUP
Potente motor de 3HP
- ✓ EXCLUSIVE 6 EDGES BLADE
Conjunto cuchilla 6 puntas /aspas
- ✓ STAINLESS STEEL SHIELDED BEARINGS
Rodamientos blindados de acero inoxidable
- ✓ KNIFE, SHAFT AND BUSHING IN STAINLESS STEEL
Conjunto de cuchilla en acero inoxidable



TRITAN™ CUP VASO DE TRITAN™

Innovative material that combines the best characteristics of glass and plastic. Ultra-resistant, free of Bisphenol A, does not release taste or smell and can be used with hot foods or cold drinks

El Eastman Tritan (tm) es un copoliéster desarrollado en 2007, que tiene transparencia, durabilidad, resistencia termica y química, superior si comparado al policarbonato y al SAN (material usualmente utilizado en la fabricación de vasos de licuadoras). Además de todos estos puntos positivos, también es libre de Bisfenol A (BPA).



SOUND ENCLOSURE CAJA REDUCTORA DE RUIDOS



Non-slip feet with height adjustment

Pies antideslizantes con ajuste de altura



Non-slip feet with height adjustment

Pies antideslizantes con ajuste de altura

MODEL / MODELO	BAR 1.5
Voltage / frequency / phases Tensión eléctrica / frecuencia / fases	127 V / 50-60 Hz / 1 220-240 V / 50-60 Hz / 1
Power rating Potencia	1.050 W 1.200 W
Consumption Consumo	1.050 W 1.200 W
Rotation Rotación	38.000 rpm
Dimensions (H x W x L) Dimensiones (Al x An x L)	460 x 255 x 265 mm
Package size (H x W x L) Dimensiones del embalaje (Al x An x L)	590 x 350 x 495 mm
Net / gross weight Peso neto / bruto	5.90 kg / 6.85 kg
Max. cup volume Volumen máximo de vaso	1,5 L
HS code Partida arancelaria	85094010



BAR1.5
WEBSITE



BAR1.5
SITIO WEB



In Skymssen you can trust.
Si es Skymssen, puedes confiar.

48

www.skymssen.com





HIGH SPEED BLENDERS 2,0 LITERS LICUADORA DE ALTA VELOCIDAD DE 2,0 LITROS

PREPARE JUICES, DRINKS AND SHAKES
PREPARE JUGOS, BEBIDAS Y BATIDOS, TRITURANDO Y LICUANDO RÁPIDAMENTE LAS PULPAS CONGELADAS.



BAR AND
RESTAURANT
BAR Y RESTAURANTE

L12 / TA2

HIGH SPEED BLENDER, STAINLESS STEEL, STAINLESS STEEL CUP, 2,0 LITERS
LICUADORA DE ALTA VELOCIDAD, INOXIDABLE, VASO EN ACERO INOXIDABLE, 2,0 LITROS

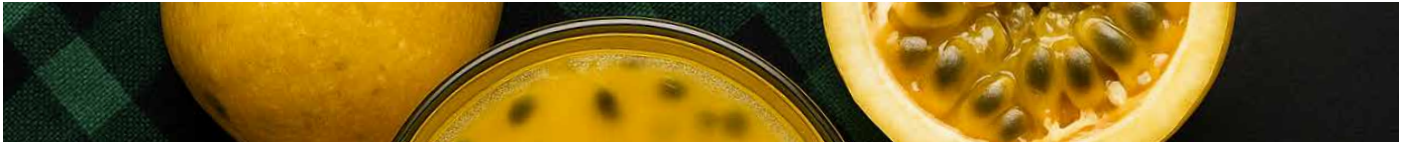

BUILT TO LAST

CONSTRUIDO PARA DURAR

Built to meet the demand of busy bars, restaurants and cafeterias, that demand a more durable equipment.

Construida para atender la demanda de bares, restaurantes y cafeterías, que necesitan un equipamiento más resistente..

- ✓ 900 W power rating
Potencia de 900 W
- ✓ Rotation 18.000 rpm
Rotación 18.000 rpm
- ✓ Removable complete cutting unit easy cleaning
Centro completo del vaso es removable facilitando la limpieza.



PERFORMANCE

DESEMPEÑO

Traditional blender with high performance and present in the market for more than 25 years.

Licuada tradicional con alto rendimiento y presente en el mercado por más de 25 años.

- ✓ 1.000 W power rating
Potencia de 1.000 W
- ✓ Rotation 22.000 rpm
Rotación 22.000 rpm



MODEL / MODELO	L12	TA2
Voltage / frequency / phases Tensión eléctrica / frecuencia / fases	110 V / 50-60 Hz / 1 220 V / 50-60 Hz / 1	110 V / 50-60 Hz / 1 220 V / 50-60 Hz / 1
Power rating Potencia	900 W	1.000 W
Rotation Rotación	18.000 rpm	22.000 rpm
Dimensions (H x W x L) Dimensiones (Al x An x L)	420 x 200 x 190 mm	450 x 215 x 205 mm
Package size (H x W x L) Dimensiones del embalaje (Al x An x L)	490 x 195 x 195 mm	490 x 195 x 195 mm
Net / gross weight Peso neto / bruto	2,17 kg / 2,80 kg	2,63 kg / 3,35 kg
Max. cup volume Volumen máximo de vaso	2 L	2 L
HS code Partida arancelaria	84386000	84386000



L12
WEBSITE

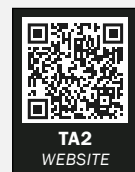

TA2
WEBSITE



L12
SITIO WEB



TA2
SITIO WEB

ILLUSTRATIVE PHOTO. ACTUAL PRODUCTS AND ACCESSORIES MAY CHANGE.
FOTO ILUSTRATIVA. PRODUCTOS REALES Y LOS ACCESORIOS PUEDEN CAMBIAR.



In Skymesen you can trust.
Si es Skymesen, puedes confiar.

49

www.skymesen.com



BRAZILIAN INDUSTRY
INDUSTRIA BRASILEIRA



HIGH SPEED BLENDERS 2,0 LITERS LICUADORAS DE ALTA VELOCIDAD DE 2,0 LITROS

PREPARE JUICES, DRINKS, SMOOTHIES AND SHAKES, CRUSH AND QUICKLY LIQUEFY FROZEN PULPS AND DRINKS WITH ICE.
PREPARE JUGOS, FROZENS, SMOOTHIES, BATIDOS Y PICAR HIELO CON AGILIDAD Y ALTA PRODUCTIVIDAD



BAR AND
RESTAURANT
BAR Y RESTAURANTE

BM2 / BS2

MAXI BLENDER, HIGH SPEED, TRITAN CUP, WITH VARIABLE SPEED, 2,0 LITERS / SUPREME BLENDER, HIGH SPEED, TRITAN CUP, WITH PREPROGRAMMED FUNCTIONS, 2,0 LITERS
MAXI BLENDER, ALTA VELOCIDAD, VASO TRITAN, CON VARIADOR DE VELOCIDAD, 2,0 LITROS / SUPREME BLENDER, ALTA VELOCIDAD, VASO TRITAN, CON FUNCIONES PRE PROGRAMADAS, 2,0 LITROS



STRENGTH AND VERSATILITY FUERZA Y VERSATILIDAD

Break ice in seconds. Create juices, smoothies and ice cream. Grind coffee beans and nuts. Prepare soups, creams and baby food.

Permite el procesamiento de diversas recetas desde jugos, batidos, smoothies, frozens hasta sopas, cremas y papillas.

- ✓ Overlid for adding ingredients during operation
Sobretapa que permite agregar alimentos mientras procesa
- ✓ 3 Pre-programmed functions
3 funciones pre programadas (en la versión BS2)
- ✓ 3 Speeds
3 velocidades
- ✓ 3 HP power rating
Potente motor de 3HP
- ✓ 38,000 RPM
Rotación 38.000 rpm
- ✓ 6 edges blade
Cuchilla de 6 puntas



TRITAN™ CUP VASO DE TRITAN™

Innovative material that combines the best characteristics of glass and plastic. Ultra-resistant, free of Bisphenol A, does not release taste or smell and can be used with hot foods or cold drinks.

El Eastman Tritan (tm) es un copoliéster desarrollado en 2007, que tiene transparencia, durabilidad, resistencia termica y quimica, superior si comparado al policarbonato y al SAN (material usualmente utilizado en la fabricación de vasos de licuadoras). Además de todos estos puntos positivos, también es libre de Bisfenol A (BPA)..

DRY OR HOT INGREDIENTS
PARA INGREDIENTES FRÍO O CALIENTE

- ✓ Stainless steel shielded bearings
Rodamientos blindados de acero inoxidable
- ✓ Knife, Shaft and Bushing in Stainless Steel
Conjunto de cuchilla en acero inoxidable
- ✓ 2 liters capacity
2 litros de capacidad



MODEL / MODELO	BM2	BS2
Voltage / frequency / phases Tensión eléctrica / frecuencia / fases	110 V / 50-60 Hz / 1 220 V / 50-60 Hz / 1	110 V / 50-60 Hz / 1 220 V / 50-60 Hz / 1
Power rating Potencia	900 W	1.000 W
Rotation Rotación	18.000 rpm	22.000 rpm
Dimensions (H x W x L) Dimensiones (Al x An x L)	420 x 200 x 190 mm	450 x 215 x 205 mm
Package size (H x W x L) Dimensiones del embalaje (Al x An x L)	490 x 195 x 195 mm	490 x 195 x 195 mm
Net / gross weight Peso neto / bruto	2,17 kg / 2,80 kg	2,63 kg / 3,35 kg
Max. cup volume Volumen máximo de vaso	2 L	2 L
HS code Partida arancelaria	84386000	84386000



In Skymesen you can trust.
Si es Skymesen, puedes confiar.

50

www.skymesen.com



ILLUSTRATIVE PHOTO. ACTUAL PRODUCTS AND ACCESSORIES MAY CHANGE.
FOTO ILUSTRATIVA. PRODUCTOS REALES Y LOS ACCESORIOS PUEDEN CAMBIAR.



HIGH SPEED BLENDERS 4,0 LITERS LICUADORA DE ALTA VELOCIDAD DE 4,0 LITROS

PREPARE JUICES, SHAKES AND COLD DRINKS.
PREPARE JUGOS, BATIDOS Y BEBIDAS FRIAS.



BAR AND
RESTAURANT
BAR Y RESTAURANTE

TA4

HIGH SPEED BLENDER, STAINLESS STEEL, STAINLESS STEEL SEAMLESS CUP, 4,0 LITERS
LICUADORA DE ALTA VELOCIDAD, INOXIDABLE, VASO MONOBLOQUE EN ACERO INOXIDABLE, 4,0 LITROS



4 LITERS AND HIGH SPEED 4 LITROS Y ALTA PRODUCCIÓN

Perfect for canteens, hotels, restaurants and buffets. Produces juices, sauces and spice based sauces in a short time. Delivers a fine and homogeneous result.

Perfecto para hoteles, restaurantes y bares. Ideal para jugos y batidos. Ofrece un resultado fino y homogéneo..

- ✓ 1.200 W power rating
Potencia de 1.200 W
- ✓ 22.000 RPM
Rotación 22.000 rpm
- ✓ Lid made of non-toxic material
Tapa de goma atóxica con alimentador
- ✓ Metal shaft and coupling
Robusto sistema de eje y acople del vaso en acero inoxidable
- ✓ Robust plug-in coupling system
Vaso con 04 litros de capacidad



Seamless cup
Vaso monobloque



MODEL / MODELO	TA4
Voltage / frequency / phases <i>Tensión eléctrica / frecuencia / fases</i>	110 V / 50-60 Hz / 1 220 V / 50-60 Hz / 1
Power rating <i>Potencia</i>	1.200 W
Rotation <i>Rotación</i>	22.000 rpm
Dimensions (H x W x L) <i>Dimensiones (Al x An x L)</i>	700 x 270 x 240 mm
Package size (H x W x L) <i>Dimensiones del embalaje (Al x An x L)</i>	455 x 310 x 545 mm
Net / gross weight <i>Peso neto / bruto</i>	4,53 kg / 6,15 kg
Max. cup volume <i>Volumen máximo de vaso</i>	4 L
HS code <i>Partida arancelaria</i>	84386000



TA4
WEBSITE



TA4
SITIO WEB

ILLUSTRATIVE PHOTO. ACTUAL PRODUCTS AND ACCESSORIES MAY CHANGE.
FOTO ILUSTRATIVA. PRODUCTOS REALES Y LOS ACCESORIOS PUEDEN CAMBIAR.



In Skymesen you can trust.
Si es Skymesen, puedes confiar.

51

www.skymesen.com



WHY CHOOSE A BLENDER WITH A ONE-PIECE CUP?

¿POR QUÉ ELEGIR UNA LICUADORA COMERCIAL CON VASO SIN SOLDADURA?



**PATENTED
PATENTADO**

WHAT IS A ONEPIECE CUP?

QUÉ ES UN VASO SIN SOLDADURA?

Manufactured using exclusive deep-drawing technology from a single piece of stainless steel, the one-piece cup is a patented innovation by Skymesen. Designed to ensure a perfect combination between its geometry and blade movement, the “V” shape allows the formation of a large vortex that directs food toward the blades—regardless of the volume—resulting in consistent blending and shorter prep times.

With no welds or seams, it features rounded corners that make cleaning and sanitizing easy, preventing residue buildup—one of the main causes of bad odors and microorganism growth.

The one-piece cups are available across the entire line of commercial blenders from 3 to 25 liters, as well as the 4-liter high-speed model. All models come with a non-toxic rubber lid and dosing cap, ensuring proper sealing and practicality.

Fabricado con tecnología exclusiva sin soldadura a partir de una única pieza de acero inoxidable. Diseñado para asegurar una combinación perfecta entre su geometría y el movimiento de las cuchillas, su forma en “V” permite la formación de un gran vórtice que dirige los alimentos hacia las cuchillas, triturando de forma homogénea y logrando el mejor resultado en menor tiempo.

Sin soldaduras ni juntas, y con esquinas redondeadas, es fácil de limpiar e higienizar, Sin acumular residuos, una de las principales causas de mal olor y proliferación de microorganismos.

Los vasos sin soldaduras están presentes en toda la línea de licuadoras comerciales de 2 hasta 25 litros, y en el modelo de alta rotación de 4 litros. Todos vienen con tapa de goma atóxica con dosificador, que garantiza un buen sellado y practicidad.

ADVANTAGES VENTAJAS



More homogeneous results

Resultado más homogéneo



Faster preparations

Preparaciones más rápidas



Processes large or small quantities

Procesa grandes o pequeñas cantidades



Does not accumulate residue

No acumula residuos



Easy to clean

Fácil de limpiar



Does not retain smell or taste

No retiene olor ni sabor



Suitable for hot and cold preparations

Permite preparaciones calientes y frías
Max. Temp. 60°C



Lid with seal and measuring cap

Tapa con cierre hermético y dosificador



COMMERCIAL BLENDERS LICUADORAS COMERCIALES

ALSO KNOWN AS LOW-SPEED BLENDERS, THEY DELIVER HIGHER TORQUE AND RESISTANCE FOR HEAVIER PREPARATIONS, SUCH AS CREAMS, SOUPS, CAKES, AND ICE CREAMS. TAMBIÉN CONOCIDOS COMO LICUADORAS DE BAJA VELOCIDAD, OFRECEN MAYOR RESISTENCIA PARA PREPARACIONES MÁS PESADAS, COMO CREMAS, SOPAS, MAYONESA Y HELADOS.



BAR AND
RESTAURANT
BAR Y RESTAURANTE

L2 / L3 / L4 / L6 / L8 / L10

STAINLESS STEEL COMMERCIAL BLENDERS WITH ONE-PIECE STAINLESS STEEL CUP
LICUADORAS COMERCIALES DE ACERO INOXIDABLE CON VASO SIN SOLDADURA DE INOXIDABLE



BETTER PERFORMANCE

MEJOR RENDIMIENTO

Ideal for cakes, soups and ice creams. Its traditional induction motor delivers the strength, durability, and high torque required for heavy-duty preparations.

Ideal para preparo de mayonesa, sopas, cremas, pre mezclas para helados, salsas más espesas, así como masas de crepas y bizcochuelo.

- ✓ Rotation speed: 3.500 rpm
Velocidad de rotación: 3.500 rpm
- ✓ Available in models from 2 to 10 liters
Disponible en modelos de 2 hasta 10 litros
- ✓ Non-toxic rubber lid with measuring cup
Tapa de goma atóxica con dosificador
- ✓ Interchangeable cups
Vasos intercambiables
- ✓ Metal shaft and coupling
Eje y acoplamiento metálicos
- ✓ Dual-voltage induction motor
Motor de inducción doble voltaje



One - piece cup
Vaso sin soldadura



MODEL / MODELO	L2	L3	L4	L6	L8	L10
Voltage / frequency / phases Tensión eléctrica / frecuencia / fases	110 V / 60 Hz / 1 220 V / 50 Hz / 1 220 V / 60 Hz / 1	110 V / 60 Hz / 1 220 V / 50 Hz / 1 220 V / 60 Hz / 1	110 V / 60 Hz / 1 220 V / 50 Hz / 1 220 V / 60 Hz / 1	110 V / 60 Hz / 1 220 V / 50 Hz / 1 220 V / 60 Hz / 1	110 V / 60 Hz / 1 220 V / 50 Hz / 1 220 V / 60 Hz / 1	110 V / 60 Hz / 1 220 V / 50 Hz / 1 220 V / 60 Hz / 1
Motor power Potencia del motor	0,5 HP-CV	0,5 HP-CV	0,5 HP-CV	0,5 HP-CV	0,5 HP-CV	0,5 HP-CV
Rated power Potencia nominal	368 W	368 W	368 W	368 W	368 W	368 W
Rated power Potencia nominal	0,67 kW-h	0,67 kW-h	0,67 kW-h	0,67 kW-h	0,67 kW-h	0,67 kW-h
Dimensions (HxWxL) Dimensiones (AlxAxN x L)	640 x 240 x 270 mm	630 x 275 x 260 mm	630 x 275 x 260 mm	720 x 310 x 300 mm	750 x 330 x 320 mm	780 x 340 x 330 mm
Package size (H x W x L) Dimensiones del embalaje (Al x An x L)	380 x 290 x 470 mm	400 x 290 x 525 mm	400 x 290 x 525 mm	455 x 310 x 545 mm	495 x 320 x 560 mm	520 x 335 x 570 mm
Net / gross weight Peso neto / bruto	8,90 kg / 10,20 kg	9,30 kg / 10,55 kg	9,5 kg / 11,00 kg	9,6 kg / 11,2 kg	10,00 kg / 11,60 kg	10,00 kg / 12,00 kg
Max. cup volume Volumen máximo del vaso	2 L	3,6 L	4 L	6 L	8 L	10 L
HS code Partida arancelaria	84386000	84386000	84386000	84386000	84386000	84386000



WEBSITE



SITIO WEB

ILLUSTRATIVE PHOTO. ACTUAL PRODUCTS AND ACCESSORIES MAY CHANGE. FOTO ILUSTRATIVA. PRODUCTOS REALES Y ACCESORIOS PUEDEN CAMBIAR.



In Skymesen you can trust.
Si es Skymesen, puedes confiar.

53

www.skymesen.com



BRAZILIAN INDUSTRY
INDUSTRIA BRASILEIRA



COMMERCIAL BLENDERS WITH REMOVABLE CUTTING UNIT LICUADORAS COMERCIALES CON MANCAL REMOVIBLE

THE HELP YOU NEED IN YOUR KITCHEN! HOUSING AND SEAMLESS CUP IN STAINLESS STEEL.
¡LA AYUDA QUE NECESITAS EN TU COCINA!



BAR AND
RESTAURANT
BAR Y RESTAURANTE

LAR-02MB / LAR-03MB / LAR-04MB / LAR-06MB / LAR-08MB / LAR-10MB

COMMERCIAL BLENDER, SATINLESS STEEL, SATINLESS STEEL SEAMLESS CUP
LICUADORA COMERCIAL, INOXIDABLE, VASO MONOBLOQUE EN ACERO INOXIDABLE



- ✓ Perfect lid sealing
Perfecto sellado de la tapa
- ✓ Robust plug-in coupling system
Sistema robusto del acople del vaso
- ✓ Easy cleaning
Fácil limpieza
- ✓ Cup capacity range from 2 to 10 liters
Capacidad del vaso de 2 hasta 10 litros
- ✓ Non-toxic lid with overlid
Tapa de material no tóxico con alimentador
- ✓ For preparation of different recipes, including warm recipes such as soups, creams and frijoles
Para la preparación de diferentes recetas, frías calientes, como sopas, cremas, mayonesas, salsas y similares



Blade
Cuchila



One - piece cup
Vaso sin soldadura

MODEL / MODELO	LAR-02MB	LAR-03MB	LAR-04MB	LAR-06MB	LAR-08MB	LAR-10MB
Voltage / frequency / phases <i>Tensión eléctrica / frecuencia / fases</i>	110/220 V / 50-60 Hz / 1	110/220 V / 50-60 Hz / 1	110/220 V / 50-60 Hz / 1	110/220 V / 50-60 Hz / 1	110/220 V / 50-60 Hz / 1	110/220 V / 50-60 Hz / 1
Motor power <i>Potencia del motor</i>	0,5 HP-CV	0,5 HP-CV	0,5 HP-CV	0,5 HP-CV	0,5 HP-CV	0,5 HP-CV
Rated power <i>Potencia nominal</i>	368 W	368 W	368 W	368 W	368 W	368 W
Rated power <i>Potencia nominal</i>	0,67 kW-h	0,67 kW-h	0,67 kW-h	0,67 kW-h	0,67 kW-h	0,67 kW-h
Consumption <i>Consumo</i>	640 x 240 x 270 mm	660 x 240 x 255 mm	660 x 290 x 280 mm	720 x 310 x 300 mm	750 x 330 x 320 mm	780 x 340 x 330 mm
Package size (H x W x L) <i>Dimensiones del embalaje (Al x An x L)</i>	380 x 290 x 470 mm	400 x 290 x 525 mm	400 x 290 x 525 mm	455 x 310 x 545 mm	495 x 320 x 560 mm	520 x 335 x 570 mm
Net / gross weight <i>Peso neto / bruto</i>	9,10 kg / 10,20 kg	9,30 kg / 10,55 kg	9,65 kg / 11,00 kg	9,85 kg / 11,45 kg	9,85 kg / 11,45 kg	9,65 kg / 11,00 kg
Max. cup volume <i>Volumen máximo del vaso</i>	2 L	3,6 L	4 L	6 L	8 L	10 L
HS code <i>Partida arancelaria</i>	84386000	84386000	84386000	84386000	84386000	84386000



WEBSITE



SITIO WEB

ILLUSTRATIVE PHOTO. ACTUAL PRODUCTS AND ACCESSORIES MAY CHANGE.
FOTO ILUSTRATIVA. PRODUCTOS REALES Y LOS ACCESORIOS PUEDEN CAMBIAR.



In Skymesen you can trust.
Si es Skymesen, puedes confiar.

54

www.skymesen.com



BRAZILIAN INDUSTRY
INDUSTRIA BRASILEIRA



COMMERCIAL TILTING BLENDERS WITH REMOVABLE CUTTING UNIT LICUADORAS COMERCIALES BASCULANTE CON MANCAL REMOVIBLE

HIGHER CAPACITY BLENDERS, IDEAL FOR RECIPES SUCH AS MAYONNAISE, CREAMS, SOUPS, SAUCES AND ICE CREAM PRE-MIXTURE
LICUADORAS DE MAYOR CAPACIDAD, IDEALES PARA RECETAS DENSAS COMO SALSAS Y CREMAS VASO BASCULANTE DE FÁCIL OPERACIÓN.



BAR AND
RESTAURANT
BAR Y RESTAURANTE

LAR-15PMB / LAR-25PMB

Commercial tilting blender, stainless steel seamless cup, 19 / 25 liters
LICUADORA COMERCIAL, BASCULANTE, VASO MONOBLOQUE, 19 / 25 LITROS



HIGH PRODUCTION ALTA PRODUCCIÓN

Ideal for making: sauces, creams, crepe dough, mayonnaise, creamy or liquid soups and ice cream pre-mixture.

Ideal para hacer: salsas, cremas, crepas, mayonesas, sopas cremosas o líquidas, puré de papas y recetas similares con verduras cocidas.

- ✓ 1,5 hp power rating
1,5 hp de potencia
- ✓ Available in 19 liters or 25 liters capacity
Disponible en 19 litros o 25 litros de capacidad nominal
- ✓ Non-toxic rubber lid with overlid
Tapa de goma atóxica con alimentador
- ✓ Double stainless steel sealing shaft with bearings for higher durability
Eje inoxidable con doble sellado y cojinete para mayor durabilidad
- ✓ Stainless steel seamless cup
Vaso sin soldadura en acero inoxidable
- ✓ Tilting cup makes operation easy
Vaso basculante de fácil operación
- ✓ Painted carbon steel stand
Caballete acero carbono pintado



Seamless cup
Vaso monobloque



MODEL / MODELO	LAR-15PMB	LAR-25PMB
Voltage / frequency / phases <i>Tensión eléctrica / frecuencia / fases</i>	110 V / 60 Hz / 1 220 V / 50 Hz / 1 220 V / 60 Hz / 1	110 V / 60 Hz / 1 220 V / 50 Hz / 1 220 V / 60 Hz / 1
Power rating <i>Potencia</i>	1,5 CV	1,5 CV
Consumption <i>Consumo</i>	1.10 kW-h	1.10 kW-h
Rotation <i>Rotación</i>	3.500 rpm 3.000 rpm 3.500 rpm	3.500 rpm 3.000 rpm 3.500 rpm
Dimensions (H x W x L) <i>Dimensiones (Al x An x L)</i>	1.120 x 365 x 525 mm	1.180 x 410 x 525 mm
Package size (H x W x L) <i>Dimensiones del embalaje (Al x An x L)</i>	1.130 x 400 x 560 mm	1.190 x 420 x 560 mm
Net / gross weight <i>Peso neto / bruto</i>	25,20 kg / 28,40 kg	25,80 kg / 28,80 kg
Max. cup volume <i>Volumen máximo de vaso</i>	19 L	25 L
HS code <i>Partida arancelaria</i>	84386000	84386000



LAR-15PMB
WEBSITE



LAR-25PMB
WEBSITE



LAR-15PMB
SITIO WEB



LAR-25PMB
SITIO WEB



In Skymssen you can trust.
Si es Skymssen, puedes confiar.

55

www.skymssen.com



ILLUSTRATIVE PHOTO. ACTUAL PRODUCTS AND ACCESSORIES MAY CHANGE.
FOTO ILUSTRATIVA. PRODUCTOS REALES Y LOS ACCESORIOS PUEDEN CAMBIAR.



COMMERCIAL BLENDERS WITH REMOVABLE CUTTING UNIT LICUADORAS COMERCIALES CON MANCAL REMOVIBLE

THE HELP YOU NEED IN YOUR KITCHEN! HOUSING AND SEAMLESS CUP IN STAINLESS STEEL.
¡LA AYUDA QUE NECESITAS EN TU COCINA!



BAR AND
RESTAURANT
BAR Y RESTAURANTE

LAR-15LMB / LAR-25LMB

COMMERCIAL BLENDER, SATINLESS STEEL, SATINLESS STEEL SEAMLESS CUP
LICUADORA COMERCIAL, INOXIDABLE, VASO MONOBLOQUE EN ACERO INOXIDABLE



HIGH PRODUCTION ALTA PRODUCCIÓN

Ideal for making: sauces, creams, crepe dough, mayonnaise, creamy or liquid soups and ice cream pre-mixture.

Ideal para hacer: salsas, cremas, crepas, mayonesas, sopas cremosas o líquidas, puré de papas y recetas similares con verduras cocidas.

- ✓ 1,5 hp power rating
1,5 hp de potencia
- ✓ Available in 19 liters or 25 liters capacity
Disponible en 19 litros o 25 litros de capacidad nominal
- ✓ Non-toxic rubber lid with overlid
Tapa de goma atóxica con alimentador
- ✓ Double stainless steel sealing shaft with bearings for higher durability
Eje inoxidable con doble sellado y cojinete para mayor durabilidad
- ✓ Stainless steel seamless cup
Vaso sin soldadura en acero inoxidable
- ✓ Tilting cup makes operation easy
Vaso basculante de fácil operación
- ✓ Painted carbon steel stand
Caballete acero carbono pintado



Seamless cup
Vaso monobloque



MODEL / MODELO	LAR-15LMB	LAR-25LMB
Voltage / frequency / phases Tensión eléctrica / frecuencia / fases	110 V / 60 Hz / 1 220 V / 50 Hz / 1 220 V / 60 Hz / 1	110 V / 60 Hz / 1 220 V / 50 Hz / 1 220 V / 60 Hz / 1
Power rating Potencia	1,5 CV	1,5 CV
Consumption Consumo	1.10 kW-h	1.10 kW-h
Rotation Rotación	3.500 rpm 3.000 rpm 3.500 rpm	3.500 rpm 3.000 rpm 3.500 rpm
Dimensions (H x W x L) Dimensiones (Al x An x L)	1.120 x 365 x 525 mm	1.180 x 410 x 525 mm
Package size (H x W x L) Dimensiones del embalaje (Al x An x L)	1.130 x 400 x 560 mm	1.190 x 420 x 560 mm
Net / gross weight Peso neto / bruto	19,00 kg / 28,40 kg	25,80 kg / 28,80 kg
Max. cup volume Volumen máximo de vaso	19 L	25 L
HS code Partida arancelaria	84386000	84386000



LAR-15LMB
WEBSITE



LAR-25LMB
WEBSITE



LAR-15LMB
SITIO WEB



LAR-25LMB
SITIO WEB

ILLUSTRATIVE PHOTO. ACTUAL PRODUCTS AND ACCESSORIES MAY CHANGE.
FOTO ILUSTRATIVA. PRODUCTOS REALES Y LOS ACCESORIOS PUEDEN CAMBIAR.



In Skymssen you can trust.
Si es Skymssen, puedes confiar.



HAND MIXER MIXER DE MANO

GRIND, BEAT, AND EMULSIFY HOT OR COLD FOODS IN LARGE QUANTITIES
TRITURAR, BATIR Y EMULSIONAR ALIMENTOS CALIENTES O FRIOS EN GRANDES CANTIDADES



BAR AND
RESTAURANT
BAR Y RESTAURANTE

MX-200 / MX-300 / MX-400 / MX-500

HAND MIXER, STAINLESS STEEL REMOVABLE ROD 230 MM (9"), 290 MM (12"), 420 MM (16"), 500 MM (20")
MIXER DE MANO, VARILLA INOXIDABLE DESMONTABLE 230 MM (9"), 290 MM (12"), 420 MM (16"), 500 MM (20")



PROFESSIONAL PREPARATIONS

PREPARACIONES PROFESIONALES

It is capable of processing a wide variety of foods, including fruits, vegetables, meats, grains and nuts. It is especially efficient in preparing soups, sauces, creams, purees, mousses, mayonnaises and other recipes that require a homogeneous and quick blend.

Es capaz de procesar una amplia variedad de alimentos, incluyendo frutas, verduras, carnes, granos y nueces. Es especialmente eficiente en la preparación de sopas, salsas, cremas, purés, mousses, mayonesas y otras recetas que requieren una mezcla homogénea y rápida.



**QUICK POT STAND FIX FOR
MODELS MX-400 AND MX-500**
SOPORTE DE OLLA RÁPIDA FIX PARA
LOS MODELOS MX-400 Y MX-500



INCLUDES WALL MOUNT
INCLUYE SOPORTE DE PARED



- ✓ High-performance motors
Motores de alto rendimiento
- ✓ Removable stainless steel shaft
Eje desmontable de acero inoxidable
- ✓ Ergonomic design
Diseño ergonómico
- ✓ Stainless steel blades
Cuchillas de acero inoxidable
- ✓ Single speed of 9,000 rpm
Velocidad única de 9.000 rpm
- ✓ Safety lock
Bloqueo de seguridad
- ✓ Continuous operation
Operación continua



MODEL / MODELO	MX-200	MX-300	MX-400	MX-500
Voltage / frequency / phases Tensión eléctrica / frecuencia / fases	110 V / 50-60 Hz / 1 220 V / 50-60 Hz / 1	110 V / 50-60 Hz / 1 220 V / 50-60 Hz / 1	110 V / 50-60 Hz / 1 220 V / 50-60 Hz / 1	110 V / 50-60 Hz / 1 220 V / 50-60 Hz / 1
Power rating Potencia	250 W	250 W	350 W	550 W
Rotation Rotación	9.000 rpm	9.000 rpm	9.000 rpm	9.000 rpm
Dimensions (H x W x L) Dimensiones (Al x An x L)	505 x 130 x 95 mm	560 x 130 x 95 mm	740 x 160 x 120 mm	815 x 160 x 120 mm
Package size (H x W x L) Dimensiones del embalaje (Al x An x L)	113 x 140 x 640 mm	113 x 140 x 640 mm	137 x 147 x 935 mm	137 x 147 x 935 mm
Net / gross weight Peso neto / bruto	2,10 kg / 2,70 kg	2,20 kg / 2,80 kg	3,80 kg / 4,50 kg	4,40 kg / 5,10 kg
Max. cup volume Volumen máximo de vaso	10 L	15 L	10 L	15 L
HS code Partida arancelaria	84388090	84388090	84388090	84388090



WEBSITE



SITIO WEB

ILLUSTRATIVE PHOTO. ACTUAL PRODUCTS AND ACCESSORIES MAY CHANGE.
FOTO ILUSTRATIVA. PRODUCTOS REALES Y LOS ACCESORIOS PUEDEN CAMBIAR.



In Skymssen you can trust.
Si es Skymssen, puedes confiar.

57

www.skymssen.com





FOOD PROCESSOR PROCESADORAS DE ALIMENTOS

BOOST YOUR BUSINESS FOOD PREPARATION WITH A COMPLETE FOOD PROCESSING SOLUTION
LLEGÓ LA SOLUCIÓN PERFECTA Y COMPLETA PARA TU NEGOCIO



BAR AND
RESTAURANT
BAR Y RESTAURANTE

PA7 PRO

STAINLESS STEEL FOOD PROCESSOR, 7 DISCS, DIAMETER 203MM
PROCESADORA DE ALIMENTOS DE ACERO INOXIDABLE, 7 DISCOS, DIÁMETRO 203MM



- ✓ **Precise and uniform cuts**
Cortes precisos y uniformes
- ✓ **Extra large feeding mouth, for large quantities**
Boca de alimentación ancha, para grandes cantidades
- ✓ **Round feeding mouth with pusher, for cylindrical shaped ingredients**
También boca menor y cilíndrica
- ✓ **Simple and easy to operate**
Simple y fácil de operar
- ✓ **Removable lid allows easy cleaning and sanitation**
Tapa removible permite llevar al fregadero
- ✓ **Safety system: Machine only turns on when the lid is closed and the pushing handle is down**
Sistema de seguridad en la tapa y empujador

NEW COMBINATION NUEVA COMBINACIÓN

7 DISCS INCLUDED
7 DISCOS INCLUIDOS

SLICERS
REBANADORES



E1
1 mm

E5
5 mm

JULIENNE
JULIENNE

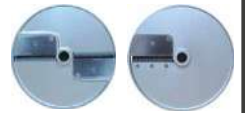

H3
3 mm

H10
10 mm

GRATERS
RALLADORES

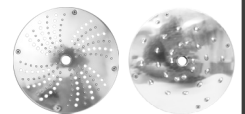

V
Fino

Z5
5 mm

DICING GRIDS
REJILLA CUBO

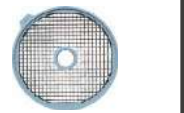

GC8 PRO
8 X 8 mm



ALSO AVAILABLE IN
VERSIONS WITHOUT DISCS OR
WITH 11 DISCS INCLUDED.

TAMBIÉN DISPONIBLE EN
VERSIONES SIN DISCOS O CON
11 DISCOS INCLUIDOS.

MODEL / MODELO	PA7 PRO
Voltage / frequency / phases <i>Tensión eléctrica / frecuencia / fases</i>	110 V / 60 Hz / 1 220 V / 50 Hz / 1 220 V / 60 Hz / 1
Power rating <i>Potencia</i>	0,5 HP
Consumption <i>Consumo</i>	0,6 kW-h
Rotation <i>Rotación</i>	440 rpm 370 rpm 440 rpm
Dimensions (H x W x L) <i>Dimensiones (Al x An x L)</i>	590 x 325 x 520 mm
Package size (H x W x L) <i>Dimensiones del embalaje (Al x An x L)</i>	640 x 400 x 620 mm
Net / gross weight <i>Peso neto / bruto</i>	27,10 kg / 32,80 kg
Approximate output <i>Salida aproximada</i>	250 kg/h
Disc diameter <i>Diámetro del disco</i>	19 L
HS code <i>Partida arancelaria</i>	84386000

20 DISCS AND GRIDS AVAILABLE! ACCESS OUR WEBSITE AND LEARN MORE

20 DISCOS Y REJILLAS DISPONIBLES! ACCEDE A
NUESTRO SITIO WEB Y APRENDE MÁS



INCLUDING A GC8 PRO CUBE CUTTING DISC (8X8MM) WHICH, COMBINED WITH THE E5 DISC (also included) RESULTS IN CUBES FOR EMPANADAS FILLINGS, SEASONING OF SOUPS, PICO DE GALLO AND SIMILAR.

INCLUIDO UN DISCO CORTE CUBO GC8 PRO (8X8MM) QUE, COMBINADO CON EL DISCO E5 (también incluido) RESULTA EN CUBOS PARA RELLENOS DE EMPANADAS, SAZÓN DE SOPAS, PICO DE GALLO Y SIMILARES



PA7 PRO
WEBSITE



PA7 PRO
SITIO WEB

ILLUSTRATIVE PHOTO. ACTUAL PRODUCTS AND ACCESSORIES MAY CHANGE.
FOTO ILUSTRATIVA. PRODUCTOS REALES Y LOS ACCESORIOS PUEDEN CAMBIAR.



In Skymssen you can trust.
Si es Skymssen, puedes confiar.

58

www.skymssen.com





FOOD PROCESSOR PROCESADORAS DE ALIMENTOS

BOOST YOUR BUSSINESS FOOD PREPARATION WITH A COMPLETE FOOD PROCESSING SOLUTION
LLEGÓ LA SOLUCIÓN PERFECTA Y COMPLETA PARA TU NEGOCIO



BAR AND RESTAURANT
BAR Y RESTAURANTE

PA7 PRO

SLICER / REBANADOR

List of discs and grids available for the PA7 PRO.
Lista de discos y rejillas cubos disponibles para el PA7 PRO.

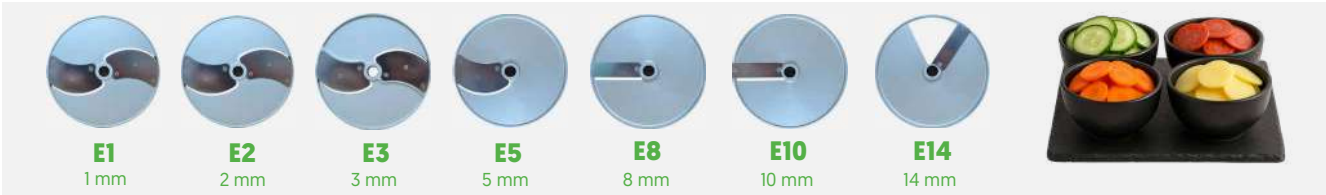

GRATER / RALLADOR FINO

GRATER / RALLADOR



SCALLOP CUT / CORTE ONDULADO

JULIENNE / JULIENNE



DICING GRIDS / REJAS CUBOS



ATTENTION: The dicing grids only perform cuts when combined with a slicing disc. Check the recommended cuts and other possible combinations in the table below.

ATENCIÓN: Las rejillas cubos solo realizan cortes cuando se combinan con un disco rebanador. Consulta los cortes recomendados y otras combinaciones posibles en la tabla al lado and other possible combinations in the table below.

COMBINATIO TABLE. COMBINACIONES	DICING DISC REJA CUBO	GC8 PRO 8 x 8 mm	GC10 PRO 10 x 10 mm	GC14 PRO 14 x 14 mm	GC20 PRO 20 x 20 mm
SLICER DISC DISCO FATIADOR		8 x 8 mm	10 x 10 mm	14 x 14 mm	20 x 20 mm
E5 5 mm	VINAGRETTA	5 x 8 x 8 mm	5 x 10 x 10 mm	5 x 14 x 14 mm	5 x 20 x 20 mm
E8 8 mm	SMALL PEQUEÑO	8 x 8 x 8 mm	8 x 10 x 10 mm	8 x 14 x 14 mm	8 x 20 x 20 mm
E10 10 mm	Do not use a slicer disc larger than a dicing grid. No utilice un disco rebanador de mayor espesor que un disco raja cubo.		MEDIUM MEDIANO	10 x 14 x 14 mm	10 x 20 x 20 mm
E14 14 mm	Do not use a slicer disc larger than a dicing grid. No utilice un disco rebanador de mayor espesor que un disco raja cubo.		Do not use a slicer disc larger than a dicing grid. No utilice un disco rebanador de mayor espesor que un disco raja cubo.	BIG GRANDE	FRUIT FRUTAS
				14 x 14 x 14 mm	14 x 20 x 20 mm

ATTENTION: The PA7 PRO dicing grids are not interchangeable with the food processor model PAIE, they are exclusive for the PA7 PRO.

ATENCIÓN: Los discos grades Cubos no son intercambiables con los modelos PAIE, solo con el PA7 Pro.



ILLUSTRATIVE PHOTO. ACTUAL PRODUCTS AND ACCESSORIES MAY CHANGE.
FOTO ILUSTRATIVA. PRODUCTOS Y REJAS Y LOS ACCESORIOS PUEDEN CAMBIAR.



In Skymssen you can trust.
Si es Skymssen, puedes confiar.



FOOD PROCESSOR
PROCESADORAS DE ALIMENTOS

PERFORM VARIOUS TYPES OF CUTS FOR VEGETABLES, GREENS, AND OTHER FOODS, HELPING WITH PREPARATION AND PORTIONING
REALIZA VARIOS TIPOS DE CORTES EN VERDURAS, HORTALIZAS Y ALIMENTOS EN GENERAL, FACILITANDO LA PREPARACION Y EL PORCIONADO



BAR AND RESTAURANT
BAR Y RESTAURANTE

DISC KIT FOR THE PA7 PRO / KIT DE DISCOS PARA EL PA7 PRO

KC5V

VINAIGRETTE DICE KIT - 8x8x5 mm

KIT CUBO VINAGRETA - 8x8x5 mm

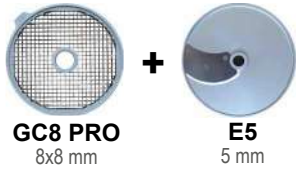

KC8

SMALL DICE KIT - 8 mm

KIT CUBO PEQUEÑO - 8 mm

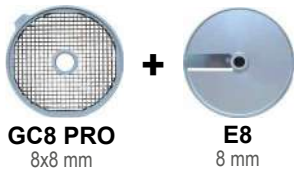

KC10

MEDIUM DICE KIT - 10 mm

KIT CUBO MEDIANO - 10 mm

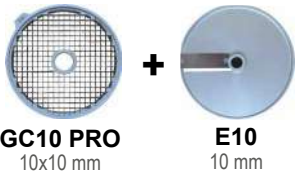

KC14

LARGE DICE KIT - 14 mm

KIT CUBO GRANDE - 14 mm



KC20F

FRUIT DICE KIT - 20x20x14 mm

KIT CUBO FRUTAS - 20x20x14 mm



PERFECT DISCS FOR YOUR BUSINESS:
DISCOS IDEALES PARA TU NEGOCIO:

PIZZERIA
PIZZERIA



BURGER SHOP
BURGUER



ALL-YOU-CAN-EAT BUFFET
RESTAURANTES SELF-SERVICE



MIXED VEGETABLES
MIX DE VERDURAS Y LEGUMBRES



ILLUSTRATIVE PHOTO. ACTUAL PRODUCTS AND ACCESSORIES MAY CHANGE.
FOTO ILUSTRATIVA. PRODUCTOS REALES Y LOS ACCESORIOS PUEDEN CAMBIAR.



In Skymssen you can trust.
Si es Skymssen, puedes confiar.



FOOD PROCESSORS PROCESADORAS DE ALIMENTOS

THE FOOD PROCESSING SOLUTION FOR HIGHER PRODUCTION NEEDS, SLICE AND GRATE IN LARGE QUANTITIES
¡OPTIMIZE LA PREPARACIÓN DE ALIMENTOS! UN PROCESADOR CON MÚLTIPLES POSIBILIDADES DE CORTE PARA DIFERENTES NECESIDADES EN LA COCINA.



BAR AND
RESTAURANT
BAR Y RESTAURANTE

PA-14-N

FOOD PROCESSOR, WITH 6 DISCS DIAMETER 429 MM
PROCESADORA DE ALIMENTOS, CON 6 DISCOS DIÁMETRO 429 MM



DISCS INCLUDED DISCOS INCLUIDOS

141-E1,5

SLICER - CORTADOR
1,5 mm



141-E3

SLICER - CORTADOR
3 mm



141-V

GRATER - RALLADOR



141-Z3

GRATER - RALLADOR
3 mm



141-Z5

GRATER - RALLADOR
5 mm



141-Z8

GRATER - RALLADOR
8 mm



A ROBUST PROCESSOR TO MEET ROBUST NEEDS EL GIGANTE DE LA LÍNEA DE PROCESADORES SKYMESEN

Processing up to 400 kg of food per hour, it has a robust structure and the largest feeding mouth in this category. Ideal for cheese processing centers and food suppliers.

Procesando hasta 400 kg de alimento por hora, tiene una estructura robusta y la boca de alimentación más grande de esta categoría. Ideal para grandes cocinas, comedores industriales y centros de procesamiento.



- ✓ Easy cleaning
Fácil limpieza
- ✓ Hardened stainless steel structure
Construcción en aluminio y acero inoxidable
- ✓ Collecting Bowl Capacity:
16.5 Liters
Capacidad del Vaso Colector: 16.5 Litros
- ✓ 160 mm diameter mouth
Boca de 160 mm de diámetro
- ✓ High production
Alta Producción



MODEL / MODELO	PA-14-N
Voltage / frequency / phases Tensión eléctrica / frecuencia / fases	110 V / 60 Hz / 1 220 V / 50 Hz / 1 220 V / 60 Hz / 1
Power rating Potencia	1 HP
Disc diameter Diámetro del disco	429 mm
Rotation Rotación	510 rpm
Dimensions (H x W x L) Dimensiones (Al x An x L)	700 x 530 x 660 mm
Package size (H x W x L) Dimensiones del embalaje (Al x An x L)	960 x 695 x 825 mm
Net / gross weight Peso neto / bruto	71,50 kg / 99,00 kg
Approximate output Producción aproximada	400 kg/h
HS code Partida arancelaria	84386000



PA-14-N
WEBSITE



PA-14-N
SITIO WEB

ILLUSTRATIVE PHOTO. ACTUAL PRODUCTS AND ACCESSORIES MAY CHANGE.
FOTO ILUSTRATIVA. PRODUCTOS REALES Y LOS ACCESORIOS PUEDEN CAMBIAR.



In Skymesen you can trust.
Si es Skymesen, puedes confiar.

61

www.skymesen.com



BRAZILIAN INDUSTRY
INDUSTRIA BRASILEIRA



GRATERS RALLADORES

SPEED AND PRODUCTIVITY FOR GRATING CHEESE, COCONUT AND VEGETABLES.
VELOCIDAD Y PRODUCTIVIDAD PARA RALLAR QUESO, COCO, CHOCOLATE Y VERDURAS.



BAR AND
RESTAURANT
BAR Y RESTAURANTE

RQC

CHEESE AND COCONUT GRATER, STAINLESS STEEL, WITH 3 DISCS
RALLADOR DE QUESO Y COCO, INOXIDABLE, CON 3 DISCOSE



HIGHER PRODUCTIVITY MAYOR PRODUCTIVIDAD

Process foods such as cheese, vegetables, coconut and chocolate in just a few seconds.

Procese alimentos como queso, verduras, coco y chocolate en solo pocos minutos.

- ✓ 0.5 HP motor with direct start
Motor de 0,5 HP
- ✓ High productivity
Alta productividad
- ✓ Easy and safe operation
Operación fácil y segura
- ✓ Easy disc switching
Fácil cambio de disco
- ✓ Made of cast aluminum and stainless steel
Fabricado en fundición de aluminio y acero inoxidable



**LARGE 120mm
DIAMETER MOUTH**
BOCA 120mm DE
DIÁMETRO



**COVER WITH
ENCAPSULATED
SHAFT**
TAPA CON EJE
ENCAPSULADO



**BOTH HANDLES WITH
200mm LENGTH FOR
GREATER FIXATION**
AMBOS MANÍPULOS CON
200mm DE LARGO PARA
MAYOR FIJACION



REINFORCED BASE
BASE REFORZADA

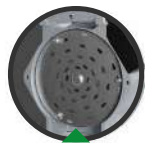

**DISCS SECURED BY
SCREWS**
CHAPA DE LOS
DISCOS FIJADOS POR
TORNILLOS

INCLUDED DISCS / DISCOS INCLUIDOS

GRATING DISC DISCOS RALLADORES

Ideal for hard cheeses and cooled chocolate
Ideal para quesos duros y chocolate



4mm SHREDDING DISC DISCO RALLADOR DE 4mm

Ideal for vegetables
Ideal para verduras



8mm SHREDDING DISC DISCO RALLADOR DE 8mm

Ideal for cheese mozzarella, chocolate and coconut.
Ideal para queso mozzarella, chocolate y coco



MODEL / MODELO	RQC
Voltage / frequency / phases Tensión eléctrica / frecuencia / fases	110 V / 60 Hz / 1 220 V / 50 Hz / 1 220 V / 60 Hz / 1
Power rating Potencia	0,5 HP-CV
Disc diameter Diámetro del disco	138 mm
Mouth diameter Diámetro de la boca	120 mm
Rotation Rotación	1.750 rpm
Dimensions (H x W x L) Dimensiones (Al x An x L)	420 x 200 x 570 mm
Package size (H x W x L) Dimensiones del embalaje (Al x An x L)	470 x 290 x 600 mm
Net / gross weight Peso neto / bruto	15,70 kg / 17,80 kg
Approximate output Producción aproximada	85 kg
HS code Partida arancelaria	84386000



RQC
WEBSITE



RQC
SITIO WEB

ILLUSTRATIVE PHOTO. ACTUAL PRODUCTS AND ACCESSORIES MAY CHANGE.
FOTO ILUSTRATIVA. PRODUCTOS REALES Y ACCESORIOS PUEDEN CAMBIAR.



In Skymssen you can trust.
Si es Skymssen, puedes confiar.

62

www.skymssen.com



BRAZILIAN INDUSTRY
INDUSTRIA BRASILEIRA



GRATERS RALLADORES

CRUSH ICE AND FROZEN FRUIT PULP FOR DISPLAY COUNTERS OF DESSERTS, ICE CREAM AND DRINKS
TRITURAR HIELO Y PULPA DE FRUTA CONGELADA PARA CÓCTELES, HELADOS Y BEBIDAS



BAR AND
RESTAURANT
BAR Y RESTAURANTE

TG

ICE CRUSHER
TRITURADOR DE HIELO



ICE AND FRUIT PULP PULPA DE FRUTAS Y HIELO

Process foods such as cheese, vegetables, coconut and chocolate in just a few seconds.

Procese alimentos como queso, verduras, coco y chocolate en solo pocos minutos.

- ✓ 0.5 HP motor with direct start
Motor de 0,5 HP
- ✓ Higher productivity in less time
Mayor productividad en menos tiempo
- ✓ Safe and easy operation
Operación fácil y segura
- ✓ Made of cast aluminum and stainless steel
Fabricado en fundición de aluminio y acero inoxidable



DISC INCLUDED
DISCO INCLUIDO



Wider Feeding Mouth with 120 mm
Boca de alimentación más ancha con 120 mm

MODEL / MODELO	TG
Voltage / frequency / phases <i>Tensión eléctrica / frecuencia / fases</i>	110 V / 60 Hz / 1 220 V / 50 Hz / 1 220 V / 60 Hz / 1
Power rating <i>Potencia</i>	0,5 HP-CV
Disc diameter <i>Diámetro del disco</i>	138 mm
Rotation <i>Rotación</i>	1.750 rpm
Dimensions (H x W x L) <i>Dimensiones (Al x An x L)</i>	410 x 200 x 565 mm
Package size (H x W x L) <i>Dimensiones del embalaje (Al x An x L)</i>	470 x 290 x 600 mm
Net / gross weight <i>Peso neto / bruto</i>	15,70 kg / 17,80 kg
Approximate output <i>Producción aproximada</i>	50 kg
HS code <i>Partida arancelaria</i>	84386000



TG
WEBSITE



TG
SITIO WEB

ILLUSTRATIVE PHOTO. ACTUAL PRODUCTS AND ACCESSORIES MAY CHANGE.
FOTO ILUSTRATIVA. PRODUCTOS REALES Y LOS ACCESORIOS PUEDEN CAMBIAR.



In Skymssen you can trust.
Si es Skymssen, puedes confiar.

63

www.skymssen.com





DOUGH OPENERS ABRIDORAS DE MASAS

IDEAL FOR OPENING PIZZA DOUGH, SFIHA, FLATBREAD AND SIMILAR. VARIOUS DIAMETERS AND THICKNESSES.
IDEAL PARA ABRIR MASA DE PIZZA, ESFIHA, PAN PLANO Y SIMILARES. VARIOS DIÁMETROS Y ESPESORES.



BAR AND
RESTAURANT
BAR Y RESTAURANTE

AMP-400 / AMP-500

CHEESE AND COCONUT GRATER, STAINLESS STEEL, WITH 3 DISCS
RALLADOR DE QUESO Y COCO, INOXIDABLE, CON 3 DISCOSE



A DOUGH OPENING REVOLUTION LA REVOLUCIÓN PARA ABRIR MASA DE PIZZA Y SIMILARES

The only opening system, that keeps the air inside the dough. Also able to create a false crust. Greater productivity and convenience for your pizzeria.

El único sistema de abrir masa, que mantiene el aire en el interior de la masa. Incluye discos para borde falso. Mayor productividad y comodidad para tu pizzería.

- ✓ To open doughs with up to 58% of humidity maximum
Abre el disco de massa con humedad de hasta el 58%

- ✓ Easy operation
Fácil operación

- ✓ Optimizes production
Optimiza la producción

- ✓ Standardizes pizza thickness
Estandariza el espesor de la masa

- ✓ Keeps the air inside the dough
Mantiene el aire dentro de la masa

- ✓ Includes 3 trays for opening Flat pizzas and false crusts in 5 different diameters
Incluye 3 bandejas de abrir masas para diferentes diámetros de disco de pizza lisa y bordes falsos (sin relleno)



DOUGH OPEN IN APPROXIMATELY 10 SECONDS
Abre un disco de masa en hasta 10 segundos

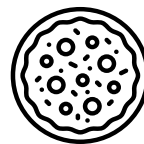

Up to Ø 40 cm
Hasta Ø 40 cm

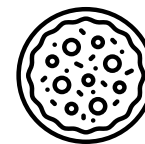

Up to Ø 50 cm
Hasta Ø 50 cm

MODEL / MODELO	AMP-400	AMP-500
Voltage / frequency / phases <i>Tensión eléctrica / frecuencia / fases</i>	110 V / 60 Hz / 1 220 V / 50 Hz / 1 220 V / 60 Hz / 1	110 V / 60 Hz / 1 220 V / 50 Hz / 1 220 V / 60 Hz / 1
Power rating <i>Potencia</i>	0,5 HP-CV	0,5 HP-CV
Dimensions (H x W x L) <i>Dimensiones (Al x An x L)</i>	760 x 705 x 590 mm	835 x 780 x 650 mm
Package size (H x W x L) <i>Dimensiones del embalaje (Al x An x L)</i>	950 x 800 x 710 mm	1.010 x 880 x 800 mm
Net / gross weight <i>Peso neto / bruto</i>	61,10 kg / 89,50 kg	96,00 kg / 128,00 kg
Max. aperture size <i>Diámetro máximo de apertura</i>	40 cm	50 cm
HS code <i>Partida arancelaria</i>	84381000	84381000



AMP-400
WEBSITE



AMP-500
WEBSITE



AMP-400
SITIO WEB



AMP-500
SITIO WEB



In Skymssen you can trust.
Si es Skymssen, puedes confiar.



DOUGH OPENERS / AMP TRAYS ABRIDORAS DE MASAS / BANDEJAS AMP

IDEAL FOR OPENING PIZZA DOUGH, SFIHA, FLATBREAD AND SIMILAR. VARIOUS DIAMETERS AND THICKNESSES
IDEAL PARA ABRIR MASA DE PIZZA, ESFIHA, PAN PLANO Y SIMILARES. VARIOS DIÁMETROS Y ESPESORES



BAR AND RESTAURANT
BAR Y RESTAURANTE

AMP-400 / AMP-500

EDGE SHAPING GROOVE TRAYS BANDEJAS CON RAÑURA QUE FORMA EL BORDE

INCLUDED INCLUIDO	4BL AMP-400	
INCLUDED INCLUIDO	4BB25/35 AMP-400	
INCLUDED INCLUIDO	4BB30/40 AMP-400	
INCLUDED INCLUIDO	5BLB40 AMP-500	
INCLUDED INCLUIDO	5BB30/45 AMP-500	
INCLUDED INCLUIDO	5BB35/50 AMP-500	
OPTIONAL OPCIONA L	5BLB37 AMP-500	
OPTIONAL OPCIONA L	5BB20/25 AMP-500	

NEAPOLITAN STYLE EDGE SHAPING GROOVE TRAYS BANDEJAS CON BORDE TIPO NAPOLITANO

OPTIONAL OPCIONA L	4BBN25/35 AMP-400	
OPTIONAL OPCIONA L	4BBN30/40 AMP-400	
OPTIONAL OPCIONA L	5BLBN40 AMP-500	
OPTIONAL OPCIONA L	5BBN30/45 AMP-500	
OPTIONAL OPCIONA L	5BBN35/50 AMP-500	

EDGE SHAPING GROOVE TRAYS BANDEJAS CON RAÑURA QUE FORMA EL BORDE

The trays with false edges help to make the edge of the pizza higher, with a traditional appearance, preventing the pizza filling from leaking during baking.

Las bandejas de falso borde regular, mantienen el relleno en el medio de la pizza, y alrededor crea lo que se llama el "cornicione" un borde de crosta crujiente y muy sabrosa.

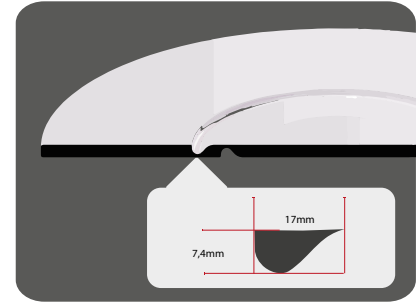

PRODUCT PRODUCTO	A-SIDE LADO A	B-SIDE LADO B	MODEL MODELO
AMP-400	FLAT LISO	FLAT LISO	4BL
	25 cm (10") EDGE 25 cm (10") BORDE	35 cm (14") EDGE 35 cm (14") BORDE	4BB25/35
	30 cm (12") EDGE 30 cm (12") BORDE	40 cm (16") EDGE 40 cm (16") BORDE	4BB30/40
AMP-500	FLAT LISO	40 cm (16") EDGE 40 cm (16") BORDE	5BLB40
	30 cm (12") EDGE 30 cm (12") BORDE	45 cm (18") EDGE 45 cm (18") BORDE	5BB30/45
	35 cm (14") EDGE 35 cm (14") BORDE	50 cm (20") EDGE 50 cm (20") BORDE	5BB35/50
	FLAT LISO	37 cm (15") EDGE 37 cm (15") BORDE	5BLB37
	20 cm (8") EDGE 20 cm (8") BORDE	25 cm (10") EDGE 25 cm (10") BORDE	5BB20/25

Sold separately - Vendida por separado

NEAPOLITAN STYLE EDGE SHAPING GROOVE TRAYS BANDEJAS CON BORDE TIPO NAPOLITANO

Napolitan-style edge trays feature the characteristics of the famous Naples pizza, with higher and wider edges.

Las bandejas de borde tipo napolitano, ofrecen un borde con las características de la pizza típica de Nápoles, con el "cornicione" un poco más ancho y alto.

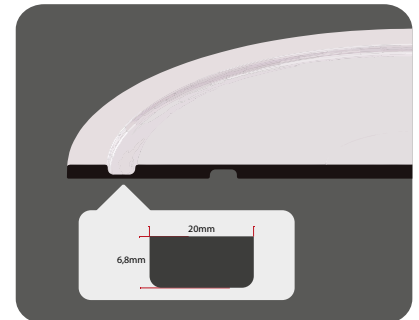

PRODUCT PRODUCTO	A-SIDE LADO A	B-SIDE LADO B	MODEL MODELO
AMP-400	25 cm (10") NAPOLITAN EDGE 25 cm (10") BORDE NAPOLITANO	35 cm (14") NAPOLITAN EDGE 35 cm (14") BORDE NAPOLITANO	4BBN25/35*
	30 cm (12") NAPOLITAN EDGE 30 cm (12") BORDE NAPOLITANO	40 cm (16") NAPOLITAN EDGE 40 cm (16") BORDE NAPOLITANO	4BBN30/40*
AMP-500	FLAT LISO	40 cm (16") NAPOLITAN EDGE 40 cm (16") BORDE NAPOLITANO	5BLBN40*
	30 cm (12") NAPOLITAN EDGE 30 cm (12") BORDE NAPOLITANO	45 cm (18") NAPOLITAN EDGE 45 cm (18") BORDE NAPOLITANO	5BBN30/45*
	35 cm (14") NAPOLITAN EDGE 35 cm (14") BORDE NAPOLITANO	50 cm (20") NAPOLITAN EDGE 50 cm (20") BORDE NAPOLITANO	5BBN35/50*

Sold separately - Vendida por separado



STONE DECK OVENS HORNOS DE PIEDRA REFRACTARIA

SPECIALLY DESIGNED FOR PIZZERIAS.
ESPECIALMENTE DISEÑADO PARA PIZZERÍAS.



BAR AND
RESTAURANT
BAR Y RESTAURANTE

FLP-400A / FLP-400D

ELECTRIC STONE DECK PIZZA OVEN, ANALOGUE / DIGITAL
HORNO DE PIEDRA REFRACTARIA PARA PIZZA, ANALÓGICO / DIGITAL



COMPACT AND PORTABLE WITH PROFESSIONAL QUALITY

COMPACTO Y PORTÁTIL CON CALIDAD PROFESIONAL

These ovens have refractory ballast stone, which retains the temperature and maintains the characteristics of pizza made in a wood-fire and economy.

Estos hornos cuentan con piedra refractaria de cordierita, que retiene la temperatura y mantiene las características de la pizza hecha en horno de leña, con mucho más control, comodidad y economía.

✓ Cordierite refractory ballast
Piedra refractaria de cordierita

✓ Economical
Económico

✓ Optimizes production
Optimiza la producción

✓ Stackable up to 3 units
Apilable hasta 3 unidades

✓ Reaches high temperatures
Alcanza altas temperaturas

✓ Perfect for pizzerias, bakeries & events
Perfecto para pizzerías, panaderías y eventos



✓ Analogue Control Panel
Digital Control Panel

✓ Maximum temperature 400 °C
Temperatura máxima 400 °C



✓ Digital Control Panel
Panel de control digital

✓ Maximum temperature 450 °C
Temperatura máxima 450 °C

✓ Double heating elements
Doble resistencias

INDEPENDENT TEMPERATURE CONTROL CONTROL INDEPENDIENTE DE TEMPERATURA

Controlling the stone heating elements and the gratinator allows you to adjust the oven to your pizza recipe.

Controlar las resistencias de la piedra y la gratinadora le permite el ajuste ideal del horno para su receta.



**Brush included for
cleaning the ballast stone**
*Cepillo incluido para limpiar la
piedra refractaria*

MODEL / MODELO	FLP-400A	FLP-400D
Voltage / frequency / phases <i>Tensión eléctrica / frecuencia / fases</i>	220 V / 50-60 Hz / 1	220 V / 50-60 Hz / 1
Power rating <i>Potencia</i>	3.300 W	3.300 W
Temperature <i>Temperatura</i>	0-400 °C	0-450 °C
Internal dimensions (HxWxL) <i>Dimensiones internas (Al x An x L)</i>	150 x 420 x 400 mm	150 x 420 x 400 mm
Dimensions (H x W x L) <i>Dimensiones (Al x An x L)</i>	310 x 700 x 710 mm	310 x 700 x 710 mm
Package size (H x W x L) <i>Dimensiones del embalaje (Al x An x L)</i>	375 x 785 x 780 mm	375 x 785 x 780 mm
Net / gross weight <i>Peso neto / bruto</i>	38,00 kg / 41,00 kg	38,00 kg / 41,00 kg
Approx. baking time (raw dough) <i>Tiempo aprox. de cocción (masa cruda)</i>	2-3 min	2-3 min
Max pizza diameter <i>Pizza diametro máximo</i>	Ø40 cm	Ø40 cm
HS code <i>Partida arancelaria</i>	85141010	85141010



FLP-400A
WEBSITE



FLP-400D
WEBSITE



FLP-400A
SITIO WEB



FLP-400D
SITIO WEB



In Skymesen you can trust.
Si es Skymesen, puedes confiar.

66

www.skymesen.com





COMMERCIAL MICROWAVE OVENS HORNOS MICROONDAS COMERCIALES

POWER AND UNIFORM HEATING WITHOUT A TURNTABLE, FEATURING A STAINLESS STEEL INTERIOR FOR EASY CLEANING AND GREATER EFFICIENCY.
POTENCIA Y CALENTAMIENTO UNIFORME SIN PLATO GIRATORIO, CON INTERIOR DE ACERO INOXIDABLE PARA FÁCIL LIMPIEZA Y MAYOR EFICIENCIA



BAR AND
RESTAURANT
BAR Y RESTAURANTE

MW1000 / MW1800D

Heatron commercial microwave 1000W / 1800W (dual magnetron)
Horno microondas comercial Heatron 1000W / 1800W (doble magnetrón)



PROFESSIONAL POWER, SUPERIOR RESULTS POTENCIA PROFESIONAL, RESULTADO SUPERIOR

Ideal for storefronts and service counters, combines technology and professionalism.

Can be stacked in two units or built into furniture.

Ideal for defrosting, reheating, or cooking raw, refrigerated, or frozen food.

Ideal para frente de tienda y mostradores de atención, una tecnología y profesionalismo. Puede apilarse en dos unidades o integrarse en el mobiliario.

Ideal para descongelar, recalentar o cocinar alimentos crudos, refrigerados o congelados.

- ✓ Different power levels and cooking stages
Diferentes niveles de potencia y etapas de preparación
- ✓ Stainless steel construction, no turntable.
Construcción en acero inoxidable, sin plato giratorio.
- ✓ Better heat distribution and uniform cooking.
Mejor distribución del calor y uniformidad en las preparaciones.
- ✓ Program up to 100 recipes
Programa hasta 100 recetas
- ✓ Light and robust door
Puerta ligera y robusta
- ✓ Intuitive panel
Panel intuitivo
- ✓ Compact and elegant design
Diseño compacto y elegante
- ✓ Includes USB drive with system for recipe customization and adjustment
Incluye pendrive con sistema para personalización y ajuste de recetas

Multi-portion mode / Modo multiporciones

Function
Función
X2

The X2 function allows the preparation of two portions at the same time, without pauses, optimizing kitchen workflow and ensuring standardization in service.

La función X2 permite preparar dos porciones al mismo tiempo, sin pausas, optimizando el ritmo de la cocina y garantizando la estandarización en el servicio.

Function
Función
X3

In the Heatron 1800 W model, the X3 function is also available for preparing three portions simultaneously.

En el modelo Heatron 1800 W, también está disponible la función X3 para preparar tres porciones simultáneas.

MODEL / MODELO	MW1000	MW1800D
Voltage / frequency / phases <i>Tensión eléctrica / frecuencia / fases</i>	220 V / 60 Hz / 1	220 V / 60 Hz / 1
Input power <i>Potencia de entrada</i>	1550 W	3000 W
Output power <i>Potencia de salida</i>	1000 W	1800 W
Internal volume <i>Volumen interno</i>	25 L	17 L
Cooking stages (time and power) <i>Etapas de cocción (tiempo y potencia)</i>	3	3
Dimensions (H x W x L) <i>Dimensiones (Al x An x L)</i>	311 x 511 x 432 mm	340 x 420 x 563 mm
Package size (H x W x L) <i>Dimensiones del embalaje (Al x An x P)</i>	380 x 581 x 478 mm	416 x 640 x 507 mm
Internal dimension (H x W x D) <i>Dimensión interna (Al x An x P)</i>	200 x 327 x 346 mm	175 x 330 x 310 mm
GN size (polycarbonate) <i>Tamaño para GN (policarbonato)</i>	GN 1/2 100 mm	GN 1/2 100 mm
Net / gross weight <i>Peso neto / bruto</i>	14,7 kg / 16,5 kg	30 kg / 32 kg
HS code <i>Partida arancelaria</i>	85141010	85141010



MW1000
WEBSITE



MW1800D
WEBSITE



MW1000
SITIO WEB



MW1800D
SITIO WEB



In Skymesen you can trust.
Si es Skymesen, puedes confiar.

67

www.skymesen.com





ICE CREAM PARLOR - HELADERÍA

In our Ice Cream Shop line, we introduce our Milkshake Mixers. Compact and easy to operate, these machines are designed to bring greater convenience and agility to the daily routine of commercial establishments. With powerful performance, they prepare milkshakes quickly and deliver a much creamier, more consistent texture – ideal for offering high-quality beverages with speed and efficiency

En nuestra línea de Heladería, presentamos nuestras Batidoras para Milkshakes. Compactas y de fácil manejo, estas máquinas están diseñadas para brindar mayor practicidad y agilidad en la rutina diaria de los establecimientos comerciales. Con un rendimiento potente, preparan milkshakes de forma rápida y con una textura mucho más cremosa y uniforme, ideal para ofrecer bebidas de alta calidad con rapidez y eficiencia.



MILKSHAKE MIXERS
BATIDORAS DE MILKSHAKE

EMULSIFY ICE CREAM AND COLD MILK TO PREPARE SHAKES AND COLD DRINKS.
EMULSIONAN HELADOS Y LECHE FRÍA PARA EL PREPARO DE MILKSHAKE Y BEBIDAS FRÍAS.

ICE CREAM
PARLOR
HELADERÍA

BMS-P / BMS-N

MILKSHAKE MIXER, STAINLESS STEEL CUP, 1 MIXER
BATIDORA DE MILKSHAKE, VASO ACERO INOXIDABLE, 1 AGITADOR



Wall-mounted model
Modelo de pared

- Modern design
Design compacto
- Stainless steel cup
Vaso de acero inoxidable
- Powerful and versatile
Alta potencia y versatilidad



**PREPARE SHAKES
DIRECTLY IN YOUR
CUP!**

**¡PREPARO DEL BATIDO
DIRECTAMENTE EN EL
VASO!**

You may use any kind of cup in the BMS. This makes preparing your milkshake and serving much easier.

Se puede usar cualquier tipo de vaso en el BMS, haciendolo más fácil y adaptable a cualquier negocio..

MODEL / MODELO	BMS-P	BMS-N
Voltage / frequency / phases <i>Tensión eléctrica / frecuencia / fases</i>	220 V / 50-60 Hz / 1	220 V / 50-60 Hz / 1
Power rating <i>Potencia</i>	200 W	200 W
Consumption <i>Consumo</i>	0,2 kW-h	0,2 kW-h
Dimensions (H x W x L) <i>Dimensiones (Al x An x L)</i>	315 x 150 x 225 mm	470 x 210 x 150 mm
Package size (H x W x L) <i>Dimensiones del embalaje (Al x An x L)</i>	370 x 210 x 270 mm	525 x 240 x 235 mm
Net / gross weight <i>Peso neto / bruto</i>	2,25 kg / 2,70 kg	3,80 kg / 4,70 kg
Rotation <i>Rotación</i>	15.000 rpm	15.000 rpm
Max. cup volume <i>Volumen máximo de vaso</i>	0,8 L	0,8 L
HS code <i>Partida arancelaria</i>	84342090	84342090



BMS-P
WEBSITE



BMS-N
WEBSITE



BMS-P
SITIO WEB



BMS-N
SITIO WEB



BAKERY - PANADERIA

The Bakery line offers a range of solutions for bakeries and pastry shops of all sizes. It includes planetary mixers in various colors, bread grinders, electric convection turbo ovens, and accessories that bring more convenience, efficiency, and flavor.

La línea de Panadería ofrece una gama de soluciones para panaderías y pastelerías de todos los tamaños. Incluye batidoras planetarias de varios colores, molinos de pan, hornos turbo eléctricos de convección y accesorios que brindan más practicidad, eficiencia y sabor.



PLANETARY MIXERS BATIDORAS PLANETARIAS

BUILT FOR REAL PERFORMANCE, THE NEW BPS5 PRO DELIVERS MORE POWER AND PRECISION IN LESS TIME. IDEAL FOR BAKERIES, PASTRY SHOPS, AND COMMERCIAL KITCHENS.
DISEÑADA PARA UN RENDIMIENTO REAL, LA NUEVA BPS5 PRO OFRECE MÁS POTENCIA Y PRECISIÓN EN MENOS TIEMPO. IDEAL PARA PANADERÍAS, PASTELERÍAS Y COCINAS INDUSTRIALES.



BAKERY
PANADERÍA

BPS5 PRO

PLANETARY MIXER, 11 SPEEDS, 5 LITERS
BATIDORA PLANETARIA, 11 VELOCIDADES, 5 LITROS.



POWER AND PERFORMANCE POTENCIA Y RENDIMIENTO

More power and technology to handle even the heaviest doughs, with stability and a 4-stage metal gear reduction system.

Más potencia y tecnología para mezclar incluso las masas más pesadas, con estabilidad y sistema de reducción de 4 etapas con engranajes metálicos.

- ✓ Stainless steel bowl with coated, ergonomic handles
Tazón de acero inoxidable con asas revestidas y ergonómicas
- ✓ Suction cup feet
Pies con ventosas de succión
- ✓ Touch panel with digital display
Panel táctil con visor digital
- ✓ Die-cast aluminum structure
Estructura de aluminio inyectado



Includes 3 beaters: spiral hook, flat beater, and whip, all made of stainless steel and redesigned for superior performance.

Incluye 3 batidores: gancho espiral, paleta y globo, todos de acero inoxidable y con nuevos formatos que garantizan un rendimiento superior.

11 SPEED SETTINGS 11 VELOCIDADES

Wide speed range for slow, delicate mixing or fast, efficient emulsifying, delivering greater consistency, better results, and quiet operation.

Amplia variación para mezclas lentas y delicadas o emulsiones rápidas y eficientes. Más consistencia, mejores resultados y funcionamiento silencioso..

MODEL / MODELO	BPS5 PRO	BPS5 PRO
Voltage / frequency / phases Tensión eléctrica / frecuencia / fases	127 V / 60 Hz / 1	220 V / 60 Hz / 1
Power rating Potencia	800 W	800 W
Consumption Consumo	0,8 kW-h	1,5 kW-h
Dimensions (H x W x L) Dimensiones (Al x An x L)	375 x 460 x 315 m	375 x 460 x 315 m
Package size (H x W x L) Dimensiones del embalaje (Al x An x L)	520 x 540 x 380 mm	520 x 540 x 380 mm
Net / gross weight Peso neto / bruto	13,50 kg / 16,00 kg	13,50 kg / 16,00 kg
Bowl volume Capacidad de la cuba	5 L	5 L
HS code Partida arancelaria	84381000	84381000



BPS5 PRO
WEBSITE



BPS5 PRO
SITIO WEB

ILLUSTRATIVE PHOTO. ACTUAL PRODUCTS AND ACCESSORIES MAY CHANGE.
FOTO ILUSTRATIVA. PRODUCTOS REALES Y ACCESORIOS PUEDEN CAMBIAR.



In Skymesen you can trust.
Si es Skymesen, puedes confiar.

71

www.skymesen.com





DOUGH ROLLERS CILINDROS DE MASAS

IDEAL FOR PIZZA, PASTRIES, PASTAS AND SIMILARS.
IDEAL PARA PANADERÍAS, PIZZERÍAS, PASTELERÍAS Y SIMILARES.



BAKERY
PANADERIA

CLM-300L / CLM-400

TABLE LAMINATING DOUGH ROLLER, STAINLESS STEEL, ROLLS OF 300 mm / 400 mm, STANDARD
CILINDRO LAMINADOR, DE BANCADA, INOXIDABLE, ROLLOS DE 300 mm Y 400 mm de largo



CLM-300L



CLM-400



- Gear driven transmission
Sistema de transmisión por engranajes
- Thickness control
Control de espesor con precisión milimétrica
- Food zones in stainless steel
Zonas de comida en acero inoxidable

- Safety guard on feed chute
Protector de seguridad en la tolva de alimentación
- Dual scrapers for upper and lower rollers
Raspadores dobles para rodillos superior e inferior
- Removable receiving area plate
Placa de recepción extraíble

FOR DAILY OPERATION PARA FUNCIONAMIENTO DIARIO

Perfect for bakeries, pastry shops,
restaurants and pizzerias.
*Perfecto para panaderías, pastelerías,
restaurantes y pizzerías.*

MODEL / MODELO	CLM-300L	CLM-400
Voltage / frequency / phases <i>Tensión eléctrica / frecuencia / fases</i>	110 V / 60 Hz / 1 220 V / 50 Hz / 1 220 V / 60 Hz / 1	110 V / 60 Hz / 1 220 V / 50 Hz / 1 220 V / 60 Hz / 1
Power rating <i>Potencia</i>	0,5 HP	1 HP
Consumption <i>Consumo</i>	0.37 kW-h	0.73 kW-h
Dimensions (H x W x L) <i>Dimensiones (Al x An x L)</i>	520 x 500 x 560 mm	650 x 600 x 800 mm
Package size (H x W x L) <i>Dimensiones del embalaje (Al x An x L)</i>	780 x 660 x 710 mm	850 x 710 x 710 mm
Net / gross weight <i>Peso neto / bruto</i>	43,50 kg / 71,00 kg	72,70 kg / 90,50 kg
Cylinder diameter <i>Diametro de los rollos</i>	62,5 mm	75,5 mm
HS code <i>Partida arancelaria</i>	84381000	84381000



In Skymssen you can trust.
Si es Skymssen, puedes confiar.

72

www.skymssen.com





BREAD CRUMB MILLS MOLINOS DE PANES

TRANSFORM TOASTED BREAD INTO BREADCRUMBS.
CONVIERTE EL PAN TOSTADO EN HARINA.



BAKERY
PANADERIA

MPAL

BREAD CRUMBS MILL, STAINLESS STEEL WITH REMOVABLE CUP
MOLINO DE PAN, ACERO INOXIDABLE Y VASO REMOVIBLE



EASY, FAST AND SAFE FÁCIL, RÁPIDO Y SEGURO

Perfect for bakeries and supermarkets.

Perfecto para panaderías y supermercados.
Ralla rápidamente y es la opción más segura del mercado.

- ✓ 6 edges milling knife
Cuchilla de molienda de 6 puntas
- ✓ Handle for easy cup removal
Manija para quitar fácilmente el vaso
- ✓ Made of stainless steel and cast aluminum
Fabricado en aluminio y acero inoxidable
- ✓ Hand protection system
Sistema de protección para las manos
- ✓ Lateral pins allow the use of a collecting bag
Pasadores de soporte para recipiente colector



REMOVABLE CUP FOR
EASY CLEANING
VASO REMOVIBLE PARA
HIGIENIZACIÓN



POWERFUL BLADES
THAT SHRED IN
SECONDS
CUCHILLAS POTENTES
QUE TRITURAN EN
SEGUNDOS

MODEL / MODELO	MPAL
Voltage / frequency / phases <i>Tensión eléctrica / frecuencia / fases</i>	110 V / 60 Hz / 1 220 V / 50 Hz / 1 220 V / 60 Hz / 1
Power rating <i>Potencia</i>	0,5 HP-CV
Dimensions (H x W x L) <i>Dimensiones (Al x An x L)</i>	675 x 310 x 315 mm
Package size (H x W x L) <i>Dimensiones del embalaje (Al x An x L)</i>	420 x 370 x 490 mm
Net / gross weight <i>Peso neto / bruto</i>	16,60 kg / 17,90 kg
HS code <i>Partida arancelaria</i>	84381000



MPAL
WEBSITE



MPAL
SITIO WEB

ILLUSTRATIVE PHOTO. ACTUAL PRODUCTS AND ACCESSORIES MAY CHANGE.
FOTO ILUSTRATIVA. PRODUCTOS REALES Y LOS ACCESORIOS PUEDEN CAMBIAR.



In Skymssen you can trust.
Si es Skymssen, puedes confiar.

73

www.skymssen.com



BRAZILIAN INDUSTRY
INDUSTRIA BRASILEÑA



DOUGH DIVIDERS DIVISORA DE MASAS

DIVIDE DOUGH WITH A ROBUST AND ECIENT TOOL.
PORCIONAMIENTO PRECISO.



BAKERY
PANADERIA

DMS-30

DOUGH DIVIDER
DIVISORA DE MASAS



PRECISE PORTIONING

PORCIONAMIENTO PRECISO

- ✓ **Stainless steel pan and knives**
Sartén y cuchillas de acero inoxidable
- ✓ **No-bac baked vannish finish**
Acabado de esmalte homeado
- ✓ **Easy to use**
Fácil de usar
- ✓ **Precise dough portions 30 individual pieces**
Porciones de masa con precisión en 30 piezas individuales
- ✓ **Takes up to 3 kg dough**
Admite hasta 3 kg de masa
- ✓ **Robust and durable**
Robusta y durables



**DOUGH CUT INTO
30 INDIVIDUAL PIECES**

*MASA CORTADA EN 30
PEDAZOS UNIFORMES*



MODEL / MODELO	DMS-30
Dimensions (H x W x L) <i>Dimensiones (Al x An x L)</i>	1.100 x 450 x 430 mm
Package size (H x W x L) <i>Dimensiones del embalaje (Al x An x L)</i>	1.180 x 530 x 530 mm
Net / gross weight <i>Peso neto / bruto</i>	33,00 kg / 54,00 kg
HS code <i>Partida arancelaria</i>	84381000



DMS-30
WEBSITE



DMS-30
SITIO WEB

ILLUSTRATIVE PHOTO. ACTUAL PRODUCTS AND ACCESSORIES MAY CHANGE.
FOTO ILUSTRATIVA. PRODUCTOS REALES Y LOS ACCESORIOS PUEDEN CAMBIAR.



In Skymssen you can trust.
Si es Skymssen, puedes confiar.

74

www.skymssen.com





CONVECTION TURBO OVENS, ELECTRICAL, FOR 10 TRAYS OF UP TO 60x70 Cm
HORNOS TURBO ELÉCTRICO, DE CONVECCIÓN, PARA 10 BANDEJAS HASTA 60X70 cm



FAST AND UNIFORM BAKING FOR BAKERIES
 COCCIÓN RÁPIDA Y UNIFORME PARA PANADERÍAS

BAKERY
 PANADERÍA

DISCOVERY 10

TURBO OVEN, ELECTRICAL, 10 TRAYS
 HORNO TURBO ELÉCTRICO, PARA 10 BANDEJAS



POWER, QUALITY AND ECONOMY
POTENCIA, CALIDAD Y ECONOMÍA

The solution for your bakery, bringing high production, comfort and energy savings.

La solución para su panadería, aportando alta producción, comodidad ahorro energético.

- ✓ Easy-to-operate panel
Panel fácil de operar
- ✓ Stainless steel construction
Fabricado en acero inoxidable
- ✓ Uniform cooking
Cocción uniforme
- ✓ Fan shutdown button
Botón de apagado de la turbina
- ✓ Casters for easy mobility
Ruedas para movilidad
- ✓ Ceramic fiber insulation
Aislamiento con fibra de cerámica



ACCESSORY SOLD SEPARATELY
PACCESORIO VENDIDO POR SEPARADO

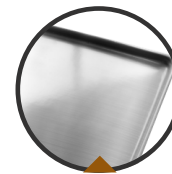

ALR-58X68
***ALUMINUM FLAT TRAY 58 x 68 cm**
 *BANDEJA PLANA DE ALUMINIO, 58 X 68 CM

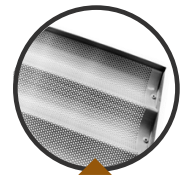

AOR-58X68
***ALUMINUM WAVY TRAY, PERFORATED 58 x 68 cm**
 *BANDEJA ONDULADA DE ALUMINIO, PERFORADA, 58 X 68 CM



High level of energy savings due to its excellent thermal insulation and temperature control system.

Alto nivel de ahorro energético debido a su excelente aislamiento térmico y sistema de control de temperatura.

MODEL / MODELO	DISCOVERY 10
Voltage / frequency / phases Tensión eléctrica / frecuencia / fases	220 V / 60 Hz / 3 220 V / 50 Hz / 3 380 V / 60 Hz / 3 380 V / 50 Hz / 3
Power rating Potencia	20.000 W
Temperature Temperatura	230 °C
Dimensions (H x W x L) Dimensiones (Al x An x L)	1.900 x 1.070 x 1.590 mm
Package size (H x W x L) Dimensiones del embalaje (Al x An x L)	2.030 x 1.310 x 1.830 mm
Net / gross weight Peso neto / bruto	326,00 kg / 425,00 kg
Breads per cycle (50g) Panecillos por ciclo (50g)	360
Height between roasting pans Altura entre bandejas para asar	110 mm
HS code Partida arancelaria	85141010



DISCOVERY 10
 WEBSITE



DISCOVERY 10
 SITIO WEB

ILLUSTRATIVE PHOTO. ACTUAL PRODUCTS AND ACCESSORIES MAY CHANGE.
 FOTO ILUSTRATIVA. PRODUCTOS REALES Y ACCESORIOS PUEDEN CAMBIAR.



In Skymesen you can trust.
 Si es Skymesen, puedes confiar.

75

www.skymesen.com



BRAZILIAN INDUSTRY
 INDÚSTRIA BRASILEIRA



DISHWASHER - LAVAVAJILLA

We proudly present our line of Commercial Dishwashers – robust, durable machines designed to bring greater savings, safety, and sustainability to your operation. Built to meet the demands of the foodservice industry, these dishwashers are ideal for restaurants, bars, cafes, bakeries, hotels, and catering companies. Engineered with high-performance standards, they ensure efficient washing cycles, reduce water and energy consumption, and promote hygiene and productivity in the kitchen, all while supporting environmentally responsible practices.

Presentamos con orgullo nuestra línea de Lavavajillas Comerciales, equipos robustos y duraderos diseñados para ofrecer mayor economía, seguridad y sostenibilidad en las operaciones del día a día. Desarrollados especialmente para satisfacer las necesidades del sector foodservice, son ideales para restaurantes, bares, cafeterías, panaderías, hoteles y empresas de catering. Estos lavavajillas garantizan ciclos de lavado eficientes, reducen el consumo de agua y energía, y promueven la higiene y la productividad en la cocina, todo con un enfoque en prácticas responsables con el medio ambiente que brindan más practicidad, eficiencia y sabor.



DISHWASHER LAVAVAJILLA

DEVELOPED TO WASH AND DRY LARGE QUANTITIES OF PLATES, GLASSES, CUTLERY, AND KITCHEN UTENSILS QUICKLY AND EFFICIENTLY.
DESARROLLADA PARA LAVAR Y SECAR GRANDES CANTIDADES DE PLATOS, VASOS, CUBIERTOS Y UTENSILIOS DE COCINA DE FORMA RÁPIDA Y EFICIENTE.



DISHWASHER
LAVAVAJILLA

PROLAV 505

UNDERCOUNTER DISHWASHER, FOR 20" (50 CM) RACKS
LAVAVAJILLAS DE APERTURA FRONTAL, PARA RACKS DE 50 CM



ECONOMICAL, HYGIENIC, AND SUSTAINABLE

ECONÓMICA, HIGIÉNICA Y SOSTENIBLE

The efficiency of your kitchen starts with a dishwasher. The PROLAV-505 washes up to 18 dishes in just 1 minute, eliminating hours of manual work and using 85% less water than conventional washing.

La eficiencia de su cocina comienza con un lavavajillas. El PROLAV-505 lava hasta 18 platos en solo 1 minuto, eliminando horas de trabajo manual y utilizando un 85% menos de agua que el lavado convencional.

- Front-opening model
Modelo de apertura frontal
- Independent rinse and wash motor pumps
Bombas de enjuague y lavado independientes
- Intuitive control panel
Panel de control intuitivo
- Audible alarm and temperature display
Alarma sonora y visor de temperatura



- Stainless steel construction
Construcción en acero inoxidable
- Installation included
Instalación incluida
- 3 washing cycles of 60, 90, and 120 s
3 ciclos de lavado de 60, 90 y 120 s
- Drawers of 50x50 cm (18 plates)
Cajones de 50x50 cm (18 platos)
- Up to 60 drawers per hour
Hasta 60 cajones por hora
- Up to 1,080 plates per hour
Hasta 1,080 platos por hora



MODEL / MODELO	PROLAV 505
Voltage / frequency / phases Tensión eléctrica / frecuencia / fases	220 V / 60 Hz / 1 220 V / 60 Hz / 3 380 V / 60 Hz / 3
Power rating / Potencia	6.200 W
Consumption / Consumo	6.2 kW-h
Dimensions (H x W x L) / Dimensiones (Al x An x L)	845 x 590 x 600 mm
Package size (H x W x L) / Dimensiones del embalaje (Al x An x L)	1.020 x 750 x 650 mm
Net / gross weight / Peso neto / bruto	60,00 kg / 71,00 kg
Rack size / Medidas del rack	50 x 50 cm
Rack capacity (12" plates) / Capacidad del rack (platos de 30cm)	18
Maximum output (plates/hour) / Producción máxima (placas/hora)	1.080
Cycle Time (washing + rising) / Ciclo completo (lavado y enjuague)	60 s / 90 s / 180 s
Useful space for washing (H x W x L) / Area útil interna (Al x An x L)	325 x 500 x 500 mm
Washing temperature / Temperatura del lavado	55°-65° C
Rising temperature / Temperatura del enjuague	80°-90° C
Motopump power rate for washing / Potencia de la bomba de lavado	0,6 kW
Motopump power rate for rising / Potencia de la motobomba del enjuague	0,25 kW
Water consumption (per cycle) / Consumo de agua (por ciclo completo)	2,7 L
Resistance power rating (wash) / Potencia de la resistencia (lavado)	5.600 W
Resistance power rating (rinse) / Potencia de la resistencia (enjuague)	5.600 W
HS code / Partida arancelaria	84221900



In Skymssen you can trust.
Si es Skymssen, puedes confiar.

77

www.skymssen.com



FOLLOW US / SIGA-NOS



Follow us on our social media! Enjoy exclusive content with the latest updates and in-depth information about our products, always bringing you the best content.

¡Síguenos en nuestras redes sociales! Disfruta de contenido exclusivo, siempre con novedades e información detallada sobre nuestros productos, brindándote siempre lo mejor

YOUTUBE



/skymssenGlobal



/skymssenGlobal

FACEBOOK



/skymssenGlobal

INSTAGRAM



INSTAGRAM



FACEBOOK



YOU TUBE

WEB SITE SKYMSSEN / SITIO WEB SKYMSSEN

Explore our complete product line! Discover solutions that will transform and make your kitchen process even more efficient. Take this opportunity to learn more about our brand and everything we have to offer.

¡Descubre toda nuestra línea de productos! Soluciones que transformarán y optimizarán aún más tus procesos en la cocina. Aprovecha también para conocer mejor nuestra marca y todo lo que tenemos para ofrecerte



WWW.SKYMSSEN.COM

Scan the QR code and check it out!
¡Escanea el código QR y échale un vistazo!



WEBSITE



SITIO WEB



In Skymssen you can trust.
Si es Skymssen, puedes confiar.

81

www.skymssen.com







**Se é Skymssen, pode confiar.
In Skymssen you can trust.
Si es Skymssen, puedes confiar.**

Metalúrgica Skymssen Ltda.

Rodovia Ivo Silveira, 9525
Volta Grande
88355-202, Brusque / SC

www.skymssen.com

Follow us:  /skymssen  /skymssenGlobal  /skymssenGlobal